



2-Phase Stepping Motors

Features	B-194
Product Specifications	B-198
Motor frame Size 28mm	B-202
Motor frame Size 35mm	B-206
Motor frame Size 42mm	B-208
Motor frame Size 56.4mm	B-220
Motor frame Size 60mm	B-230
Motor frame Size 85mm	B-236

2-Phase Stepping Motors

High-Torque PK Type



■ Features of the PK High-Torque 2-Phase Stepping Motors

Stepping motors are capable of highly precise and reliable operation without the use of position detectors. Motor operation is controlled directly through pulse signals, whereby the current flowing through the motor's windings is switched with each pulse signal input, causing the motor to rotate in steps at fixed angles.

1. Wide Variety

Six frame sizes are available in a range from 28mm to 85mm. In addition to the standard type, we offer **P** type (High response), **J** type (High inertia capability), **M** type (High resolution) and **SH** geared type. The coil also comes in various specifications.

2. High Torque

This high torque of the **PK** series motor makes it possible to drive large equipment and is effective for equipment downsizing and for keeping heat generation low.

3. Low Vibration

The **PK** series motors do more than provide high torque: they were also designed to achieve smooth operations. This makes **PK** series motors the ideal choice for micro-step driving.

4. Low Audible Noise

The **PK** series motor was designed to produce low audible noise.

QSTEP

RK

CSK

PMC

NanoStep
REK5-Phase
Stepping
Motors

CSK

2-Phase
Stepping
Motors

Controller

Accessories

Variations

Type \ Size	Motor Frame Size (mm)					
	□28	□35	□42	□56.4	□60	□85
Standard Type	—	—	○	○	—	○
Standard Terminal Box Type	—	—	—	—	—	○
P Type (High Response)	○	○	○	—	—	—
J Type (High Inertia Capability)	—	—	—	—	○	—
M Type (High Resolution)	—	—	○	○	—	—
SH Geared Type	○	—	○	○*1	—	○*2

*1 Gearhead frame size is □60mm

*2 Gearhead frame size is □90mm

P Type (High Response)

High torque

This type combines high torque and a compact body. Three frame sizes, 28 mm, 35 mm and 42 mm, are available. Each specification provides torque equivalent to a motor of the next higher class, supporting high-torque operation even in the high-speed range.

For example, **P** type **PK246PA** (motor frame size □42mm) has the same holding torque as the standard type **PK266-01A** (motor frame size □56.4mm). You can choose smaller size motor to attain the same torque. It contributes to miniaturizing and making equipment lightweight.

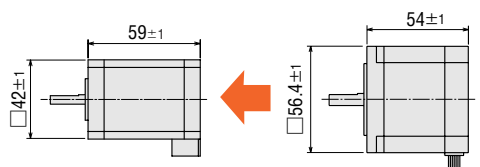
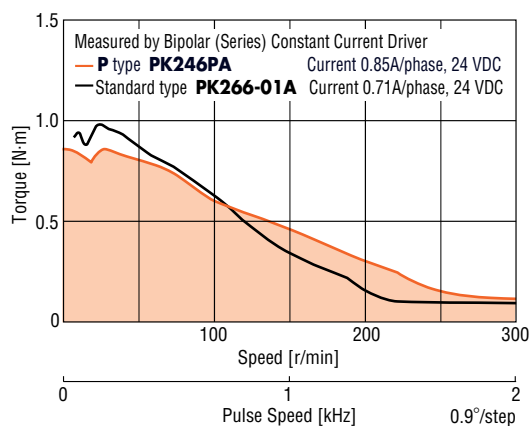

P type	Type	Standard type
PK246PA	Model	PK266-01A
0.93 N·m	Holding Torque	1.17 N·m
$114 \times 10^{-7} \text{ kg} \cdot \text{m}^2$	Rotor Inertia	$300 \times 10^{-7} \text{ kg} \cdot \text{m}^2$

J Type (High Inertia Capability)

Ideal for driving loads subject to large inertia.

A large rotor size means the rotor's inertia is large, as well. Motor response improves as the ratio of the equipment's external inertia and rotor inertia decreases and the generated torque increases. Therefore, if the total inertia of the setup is large, the **J** type is the best choice, since it offers high power and large rotor inertia.

High Torque

The **J** type provides, on average, 1.5 times higher torque than the standard type.

With the rotor size larger, the rotor is composed of permanent magnets, its higher torque is successfully realized.

Our skillful winding technology makes it possible to maximize the rotor space.

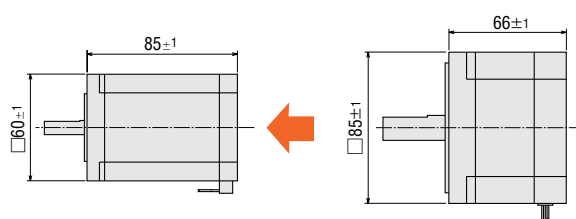
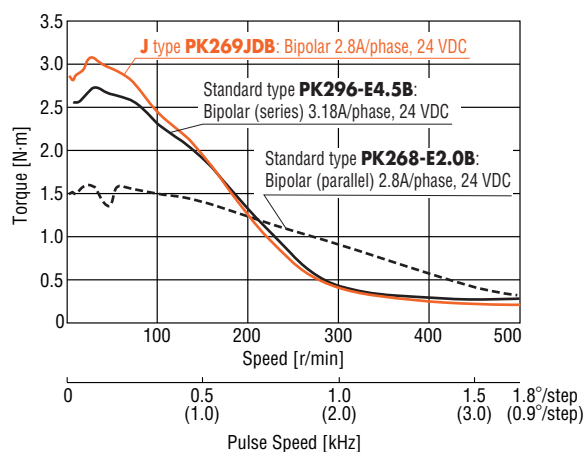

J Type	Type	Standard Type
PK269JDA	Model	PK296-E4.5A
3.10 N·m	Holding Torque	3.10 N·m

High Positioning Accuracy

The **J** type has dramatically improved accuracy, with a static angle error $\pm 0.034^\circ$ (standard type: $\pm 0.05^\circ$). The **J** type is better at overcoming external load forces, providing your equipment with more accurate positioning and stability.

J Type

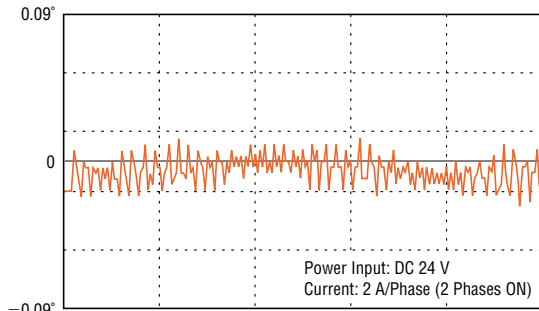

Standard Type

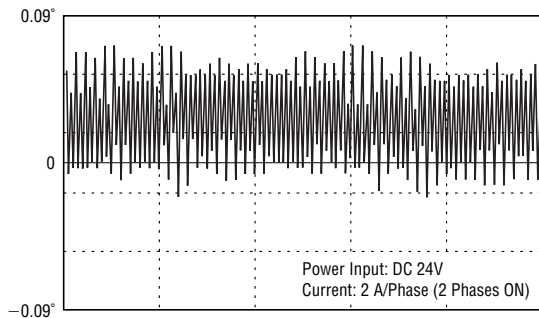

Angle-Torque Characteristics

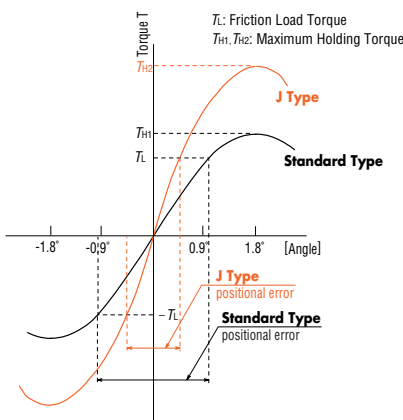

All equipment has friction load, and the motor stops when the motor output torque and friction load torque are balanced. As shown in the characteristics above, the larger the output torque per step angle, the less the motor is influenced by friction load, so positioning accuracy is improved. Stop positioning displacement by external force does not occur as often.

M Type (High Resolution)

The 2-phase, high resolution stepping motor has half the step angle of the standard stepping motor. The **M** Type increases motor resolution from 200 steps/revolution to 400 steps/revolution. If an even smaller step-angle is needed, half-step driving and micro-step driving are other options. Such options, however, do not improve accuracy. The excitation coil of the 2-phase, high resolution stepping motor is located in exactly the same position, the number of rotor teeth is twice as many as standard stepping motors. Other structures are exactly the same as the standard motors.

• Please refer to page B-14 for more installation.

SH Geared Type

Incorporating **SH** gears with high permissible torque, these models offer the full benefit of geared motors' deceleration capability, delivering high resolution, high torque and smooth low-speed rotation. With performance like this, **SH** geared type can easily satisfy the requirements of various kinds of low-speed positioning applications.

Smooth Rotation at Low Speeds

When operated independently, motors develop high rotational vibration at low speeds, which makes step-like motion more noticeable. Reducing motor speed by means of the gear unit results in much smoother low-speed rotation.

Six Reduction Gear Ratios

Gear units in the **SH** geared type are available in six different reduction gear ratios: 1:3.6, 1:7.2, 1:9, 1:10, 1:18, 1:36. The low ratios of these units can greatly facilitate speed control of the 2-phase stepping motors.

* **PK223-SG** type has five gear ratios except 1:3.6.

Ideal for High Inertia Drive

The stepping motor itself can drive the inertia of 10 times the rotor inertia. The geared type can drive this inertia multiple by the square of the speed reduction ratio. Therefore, the geared type is suitable for driving an inertial body.

General Specifications

Item	Specifications
Shaft Runout	0.05 T.I.R (mm) ^{*1}
Perpendicularity	0.075 T.I.R (mm) ^{*1}
Concentricity	0.075 T.I.R (mm) ^{*1}
Shaft Raadial Play ^{*2}	0.025 mm Maximum of 5 N
Shaft Axial Play ^{*3}	0.075 mm Maximum of 10 N
Stop position Accuracy ^{*4}	±0.05° (J type: ±0.034°)
Insulation Resistance	100 MΩ or more under normal ambient temperature and humidity when the megger reading between the windings and frame is DC500 V.
Dielectric Strength	Under normal ambient temperature and humidity, sufficient to withstand 1 kV (0.5 kV ^{*5} , 1.5 kV ^{*6}) at 50 Hz applied between the windings and the case for one minute following a period of continuous operation.
Insulation Class	Class B (130°C)
Temperature Rise	80°C or less as measured by the Resistance Change method when 2 phases are excited at rated voltage at rest.
Ambient Temperature Range	-10°C~+50°C

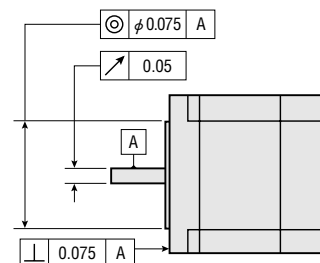

- *1 T.I.R (Total Indicator Reading): It refers to the total dial gage reading when the measurement section is rotated 1 revolution centered on the reference axis center.
- *2 Radial Play: It refers to the displacement in shaft position in the radial direction when a 5 N load is placed vertically on the motor shaft tip.
- *3 Axial Play: It refers to the displacement in shaft position in the axial direction when a 10 N load is placed on the motor shaft in the axial direction.
- *4 Stop position Accuracy: This value is for full step with no load. (The value changed with size of load.)
- *5 For motors with a motor size of 42 mm×42 mm or less, 50 Hz, 0.5 kV for 1 minute.
- *6 For standard terminal box type motors with a motor size of 85 mm×85 mm, 50 Hz, 1.5 kV for 1 minute.

Wirings and Connections

Motor Wirings

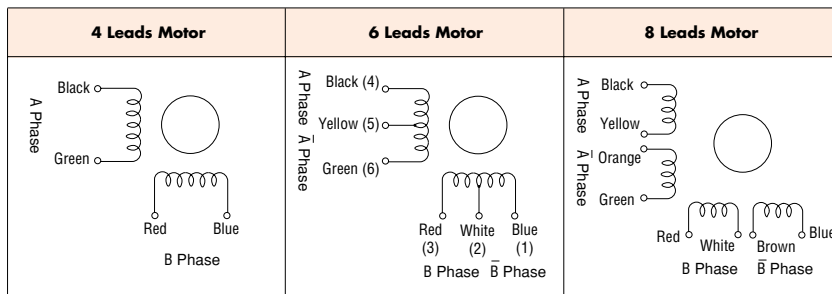

Notes on Characteristic Diagrams

The speed-torque characteristics featured in this catalogue are as measured on a constant-current driver.

The actual characteristics will vary depending on the driver used. Please use these diagrams only for reference purposes when selecting a motor.

You must also conduct a thorough evaluation with the actual driver to be used.

Wirings Connection Diagram

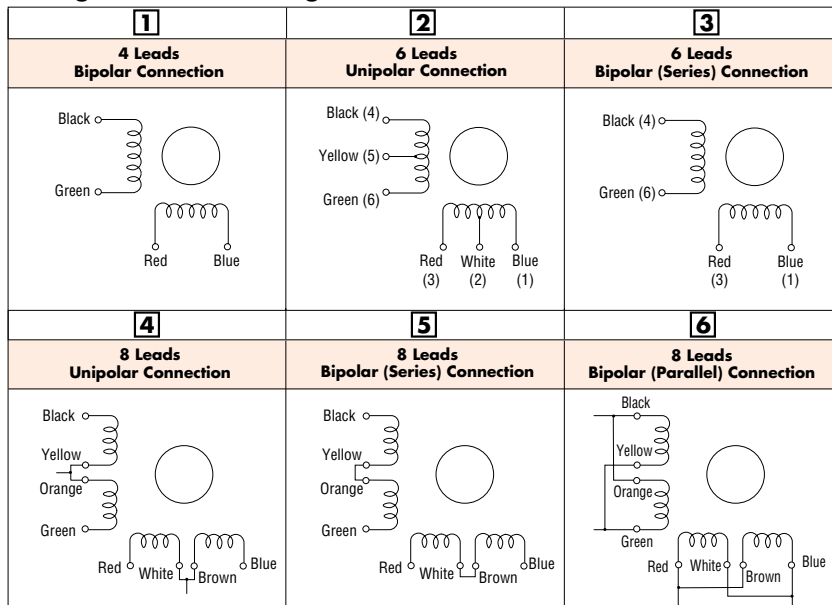

Product Specifications (Bipolar Series)

Frame Size 28 mm PK22□

Type	Model Single Shaft Double Shaft	Basic Step Angle	Holding Torque N·m	Current per Phase A/phase	Voltage V DC	Resistance per Phase Ω/phase	Inductance mH/phase	Rotor Inertia J kg·m ²	Mass kg	page
P Type (High Response)	PK223PA PK223PB	1.8°	0.065	0.67	3.8	5.6	4	9×10 ⁻⁷	0.11	B-202
	PK224PA PK224PB		0.097		4.6	6.8	4.8	12×10 ⁻⁷	0.14	
	PK225PA PK225PB		0.11		6.2	9.2	5.6	18×10 ⁻⁷	0.2	
SH G geared Type	PK223PA-SG7.2 PK223PB-SG7.2	0.25°	0.3	0.67	3.8	5.6	4	9×10 ⁻⁷	0.16	B-204
	PK223PA-SG9 PK223PB-SG9	0.2°					4			
	PK223PA-SG10 PK223PB-SG10	0.18°					4			
	PK223PA-SG18 PK223PB-SG18	0.1°					4			
	PK223PA-SG36 PK223PB-SG36	0.05°					4			

* The value given for holding torque is the value when operated with rated voltage and 2-phase excitation.

Frame Size 35 mm PK23□

Type	Model Single Shaft Double Shaft	Basic Step Angle	Holding Torque N·m	Current per Phase A/phase	Voltage V DC	Resistance per Phase Ω/phase	Inductance mH/phase	Rotor Inertia J kg·m ²	Mass kg	page
P Type (High Response)	PK233PA PK233PB	1.8°	0.2	0.85	4.6	5.4	5.6	24×10 ⁻⁷	0.18	B-206
	PK235PA PK235PB		0.37		5.8	6.8	8	50×10 ⁻⁷	0.285	

* The value given for holding torque is the value when operated with rated voltage and 2-phase excitation.

Frame Size 42 mm PK24□

Type	Model Single Shaft Double Shaft	Basic Step Angle	Holding Torque N·m	Current per Phase A/phase	Voltage V DC	Resistance per Phase Ω/phase	Inductance mH/phase	Rotor Inertia J kg·m ²	Mass kg	page			
Standard Type	PK243-01A PK243-01B	1.8°	0.2	0.67	5.6	8.4	10	35×10 ⁻⁷	0.21	B-208			
	PK243-02A PK243-02B			0.28	13	48	60						
	PK243-03A PK243-03B			0.22	17	77	84						
	PK244-01A PK244-01B		0.33	0.85	5.6	6.6	12.8	54×10 ⁻⁷	0.27				
	PK244-02A PK244-02B			0.57	8.6	15	26.8						
	PK244-03A PK244-03B			0.28	17	60	120						
	PK245-01A PK245-01B		0.43	0.85	5.6	6.6	11.2	68×10 ⁻⁷	0.35				
	PK245-02A PK245-02B			0.57	8.6	15	28.4						
	PK245-03A PK245-03B			0.28	17	60	100						
	P Type (High Response)		PK244PA PK244PB	1.8°	0.48	0.85	6.8	8	15.6		57×10 ⁻⁷	0.3	B-212
			PK246PA PK246PB		0.93	0.85	10	12	26		114×10 ⁻⁷	0.5	
			M Type (High Resolution)		PK243M-01A PK243M-01B	0.9°	0.2	0.67	5.6		8.4	15.2	
PK243M-02A PK243M-02B		0.42			8.4			20	38.8				
PK243M-03A PK243M-03B	0.22	17		77	136								
PK244M-01A PK244M-01B	0.31	0.85		5.6	6.6		17.2	54×10 ⁻⁷	0.3				
PK244M-02A PK244M-02B		0.57		8.6	15		38.8						
PK244M-03A PK244M-03B		0.28		17	60		152						
PK245M-01A PK245M-01B	0.38	0.85		5.6	6.6		15.6	68×10 ⁻⁷	0.37				
PK245M-02A PK245M-02B		0.57		8.6	15		39.6						
PK245M-03A PK245M-03B		0.28		17	60		128						
SH Geared Type	PK243A1-SG3.6 PK243B1-SG3.6	0.5°		0.2	0.67		5.6	8.4	10	35×10 ⁻⁷	0.35	B-218	
	PK243A1-SG7.2 PK243B1-SG7.2	0.25°	0.4										
	PK243A1-SG9 PK243B1-SG9	0.2°	0.5										
	PK243A1-SG10 PK243B1-SG10	0.18°	0.56										
	PK243A1-SG18 PK243B1-SG18	0.1°	0.8										
	PK243A1-SG36 PK243B1-SG36	0.05°	0.8										

Frame Size 56.4 mm **PK26** (Frame size of **SH** geared type is 60mm)

Type	Model Single Shaft Double Shaft	Basic Step Angle	Holding Torque N·m	Current per Phase A/phase	Voltage V DC	Resistance per Phase Ω/phase	Inductance mH/phase	Rotor Inertia J kg·m ²	Mass kg	page	
Standard Type	PK264-01A PK264-01B	1.8°	0.48	0.71	8.1	11.4	21.6	120×10 ⁻⁷	0.45	B-220	
	PK264-02A PK264-02B			1.4	3.9	2.8	5.6				
	PK264-03A PK264-03B			2.1	2.6	1.26	2.4				
	PK264-E2.0A PK264-E2.0B			1.4	3.9	2.8	5.6				
	PK266-01A PK266-01B			1.17	0.71	11	14.8				40
	PK266-02A PK266-02B	5	3.6			10					
	PK266-03A PK266-03B	3.2	1.5			4.4					
	PK266-E2.0A PK266-E2.0B	5	3.6			10					
	PK268-01A PK268-01B	1.75	0.71	12	17.2	56	480×10 ⁻⁷	1			
	PK268-02A PK268-02B				6.3	4.5			14.4		
	PK268-03A PK268-03B				4.2	2			6.4		
	PK268-E2.0A PK268-E2.0B				6.3	4.5			14.4		
	PK264M-01A PK264M-01B				M Type (High Resolution)	0.9°			0.48		8.1
	PK264M-02A PK264M-02B	3.9	2.8	6.8							
	PK264M-03A PK264M-03B	2.6	1.26	3							
PK264M-E2.0A PK264M-E2.0B	3.9	2.8	6.8								
PK266M-01A PK266M-01B	1.17	0.71	11	14.8			50.8	300×10 ⁻⁷		0.7	
PK266M-02A PK266M-02B				5		3.6	12.8				
PK266M-03A PK266M-03B				3.2		1.5	5.8				
PK266M-E2.0A PK266M-E2.0B				5		3.6	12.8				
PK268M-01A PK268M-01B	1.75	0.71	12	17.2		77.6	480×10 ⁻⁷	1			
PK268M-02A PK268M-02B				6.3		4.5			19.2		
PK268M-03A PK268M-03B				4.2		2			8.4		
PK268M-E2.0A PK268M-E2.0B				6.3		4.5			19.2		
PK264AE-SG3.6 PK264BE-SG3.6				SH Geared Type		0.5°			1	1.4	3.9
PK264AE-SG7.2 PK264BE-SG7.2	0.25°	2									
PK264AE-SG9 PK264BE-SG9	0.2°	2.5									
PK264AE-SG10 PK264BE-SG10	0.18°	2.7									
PK264AE-SG18 PK264BE-SG18	0.1°	3									
PK264AE-SG36 PK264BE-SG36	0.05°	4									

QSTEP

RK

CSK

PMC

NanoStep RK

5-Phase Stepping Motors

CSK

2-Phase Stepping Motors

Controller

Accessories

Frame Size 60 mm PK26□J

Type	Model Single Shaft Double Shaft	Basic Step Angle	Holding Torque	Current per Phase	Voltage	Resistance per Phase	Inductance	Rotor Inertia J	Mass	page
			N·m	A/phase	V DC	Ω/phase	mH/phase	kg·m ²	kg	
J Type (High Inertia Capability)	PK264JDA PK264JDB	1.8°	1.06	2.8	2.1	0.73	1.8	280×10 ⁻⁷	0.6	B-232
	PK264JA PK264JB		1.06	1.4	4.1	2.92	7.2			
	PK266JDA PK266JDB		1.75	2.8	2.8	1	3.05	450×10 ⁻⁷	0.83	
	PK266JA PK266JB		1.75	1.4	5.6	4	12.2			
	PK267JDA PK267JDB		2.2	2.8	3.4	1.2	3.54	570×10 ⁻⁷	1.02	
	PK267JA PK267JB		2.2	1.4	6.7	4.8	14.2			
	PK269JDA PK269JDB		3.1	2.8	4.2	1.49	5.7	900×10 ⁻⁷	1.43	
	PK269JA PK269JB		3.1	1.4	8.3	5.96	22.8			

* The value given for holding torque is the value when operated with rated voltage and 2-phase excitation.

Frame Size 85 mm PK29□ (Frame size of SH geared type is 90mm)

Type	Model Single Shaft Double Shaft	Basic Step Angle	Holding Torque	Current per Phase	Voltage	Resistance per Phase	Inductance	Rotor Inertia J	Mass	page
			N·m	A/phase	V DC	Ω/phase	mH/phase	kg·m ²	kg	
Standard Type	PK296-E4.5A PK296-E4.5B	1.8°	3.1	3.18	2.8	0.96	6	1400×10 ⁻⁷	1.7	B-236
	PK299-E4.5A PK299-E4.5B		6.2	3.18	3.9	1.32	10	2700×10 ⁻⁷	2.8	
	PK2913-E4.0A PK2913-E4.0B		9.3	2.8	5.3	1.94	16.8	4000×10 ⁻⁷	3.8	
Standard (Terminal Box Type)	PK296-E4.5T	1.8°	3.1	3.18	2.8	0.96	6	1400×10 ⁻⁷	2.1	B-236
	PK299-E4.5T		6.2	3.18	3.9	1.32	10	2700×10 ⁻⁷	3.2	
	PK2913-E4.0T		9.3	2.8	5.3	1.94	16.8	4000×10 ⁻⁷	4.3	
SH Geared Type	PK296AE-SG3.6 PK296BE-SG3.6	0.5°	2.5	2.1	2	0.96	6.0	1400×10 ⁻⁷	2.8	B-240
	PK296AE-SG7.2 PK296BE-SG7.2	0.25°	5							
	PK296AE-SG9 PK296BE-SG9	0.2°	6.3							
	PK296AE-SG10 PK296BE-SG10	0.18°	7							
	PK296AE-SG18 PK296BE-SG18	0.1°	9							
	PK296AE-SG36 PK296BE-SG36	0.05°	12							

Speed-Torque Characteristics fs: Maximum Starting Pulse Rate

PK223PB Bipolar (Series)

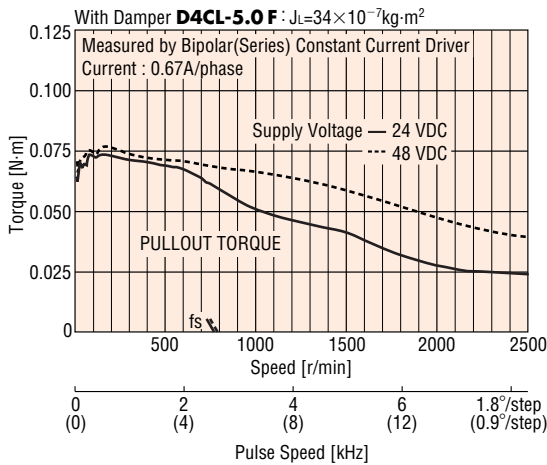

PK223PB Unipolar

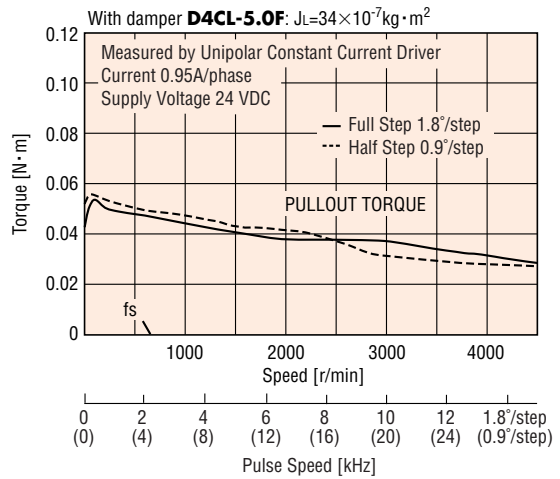

PK224PB Bipolar (Series)

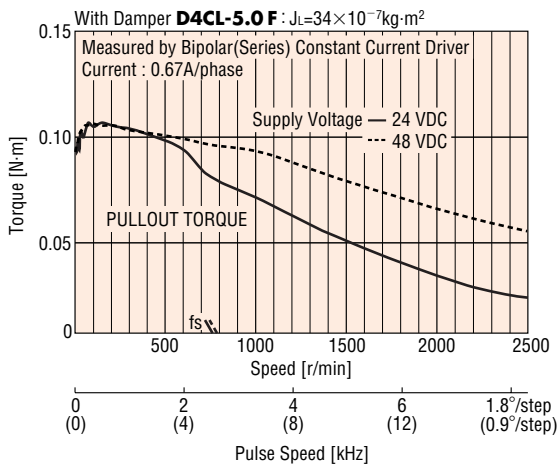

PK224PB Unipolar

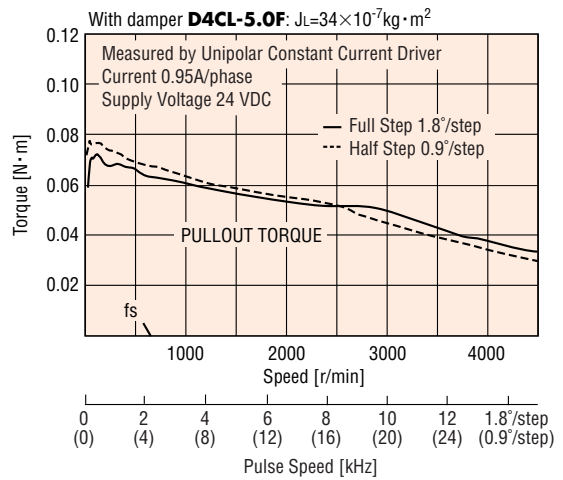

PK225PB Bipolar (Series)

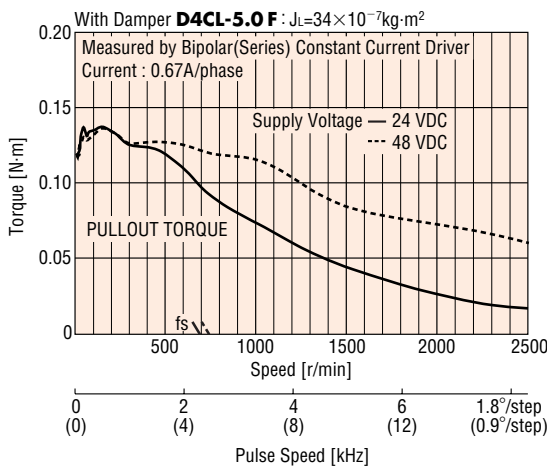

PK225PB Unipolar

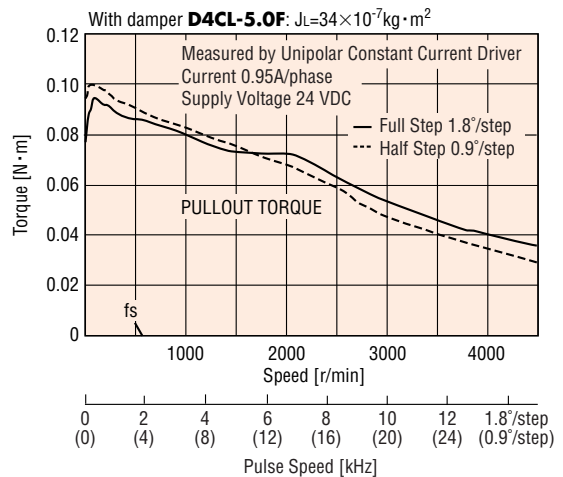

Optional Cable (Sold separately)

These connector cables make it easy to connect the **P** type motor. The crimped connectors eliminate the need for assembly. There are two cable lengths to choose from.

Model	Cable Length (mm)	Number of Leads	Leads Specifications	
			UL Style No.	AWG No.
LC2U06A	600	6 Leads	3265	24
LC2U10A	1000			



SH Geared Type

28mm



Specifications

● Motor Specifications

Model	Connection Type	Current per Phase	Voltage	Resistance per Phase	Inductance	Rotor Inertia J	Lead Wires (Pin)	Connection Diagram
Single Shaft Double Shaft		A/phase	V DC	Ω/phase	mH/phase	kg·m ²		(see page B-197)
PK223PA-SG □	Bipolar (Series)	0.67	3.8	5.6	4	9×10 ⁻⁷	6	3
PK223PB-SG □	Unipolar	0.95	2.66	2.8	1			2

*Enter the gear ratio in the box (□) within the model name.

●Degree of Protection: IP30

● Gearmotor Specifications

Model	Gear Ratio	Holding Torque	Step Angle	Permissible Speed	Permissible Thrust Load	Permissible Overhung Load
Single Shaft Double Shaft		N·m		r/min	N	(at 10mm from shaft end) N
PK223PA-SG7.2 PK223PB-SG7.2	1:7.2	0.3	0.25°	250	10	20
PK223PA-SG9 PK223PB-SG9	1:9	0.3	0.2°	200	10	20
PK223PA-SG10 PK223PB-SG10	1:10	0.3	0.18°	180	10	20
PK223PA-SG18 PK223PB-SG18	1:18	0.4	0.1°	100	10	20
PK223PA-SG36 PK223PB-SG36	1:36	0.4	0.05°	50	10	20

■ Dimensions unit: mm

- **PK223PA-SG**□ (Single Shaft) Mass 0.16 kg
- **PK223PB-SG**□ (Double Shaft) Mass 0.16 kg

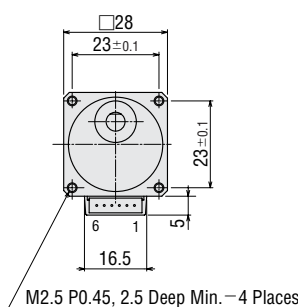
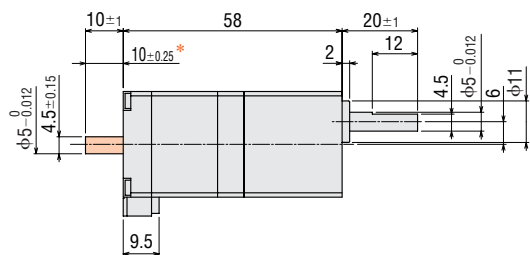

Mounting Screws (included)
M2.5 P0.45 8mm long : 4 pieces

*10±0.25 indicates the length of milling on motor shaft.

● This dimension is for double shaft models. For single shaft, ignore the colored area.

Applicable Connector

The following housing and contacts must be purchased separately.

Housing: 51065-0600 (MOLEX)

Contact: 50212-8XXX (MOLEX)

Speed-Torque Characteristics

fs: Maximum Starting Pulse Rate

● **PK223PB-SG** □ Bipolar (Series) 24 VDC

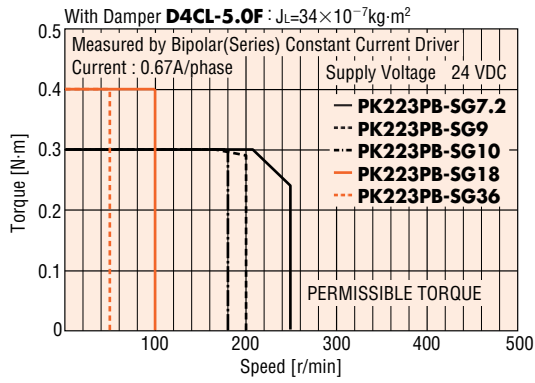

● **PK223PB-SG** □ Unipolar

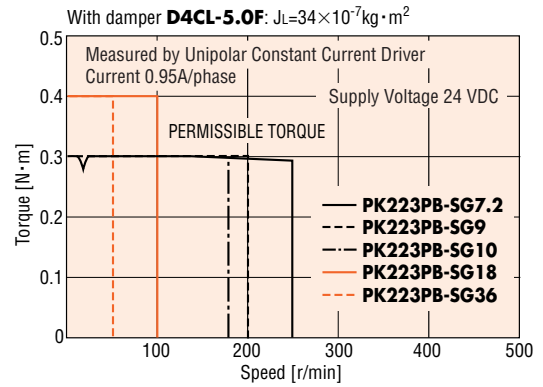

● **PK223PB-SG** □ Bipolar (Series) 48 VDC

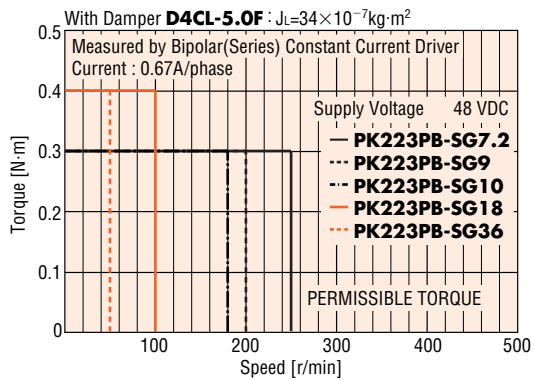

Optional Cable (Sold separately)

These connector cables make it easy to connect the **P** type motor. The crimped connectors eliminate the need for assembly. There are two cable lengths to choose from.

Model	Cable Length (mm)	Number of Leads	Leads Specifications	
			UL Style No.	AWG No.
LC2U06A	600	6 Leads	3265	24
LC2U10A	1000			



P Type (High Response)

35mm

Step Angle 1.8°



Specifications

Model	Connection Type	Holding Torque	Current per Phase	Voltage	Resistance per Phase	Inductance	Rotor Inertia J	Lead Wires (Pin)	Connection Diagram (see page B-197)
Single Shaft Double Shaft		N·m	A/phase	V DC	Ω/phase	mH/phase	kg·m ²		
PK233PA	Bipolar (Series)	0.2	0.85	4.6	5.4	5.6	24×10 ⁻⁷	6	[3]
PK233PB	Unipolar	0.16	1.2	3.24	2.7	1.4			[2]
PK235PA	Bipolar (Series)	0.37	0.85	5.8	6.8	8	50×10 ⁻⁷	6	[3]
PK235PB	Unipolar	0.3	1.2	4.08	3.4	2			[2]

●Degree of Protection: IP30

Dimensions unit: mm

- **PK233PA** (Single Shaft) Mass 0.18 kg
- **PK233PB** (Double Shaft) Mass 0.18 kg

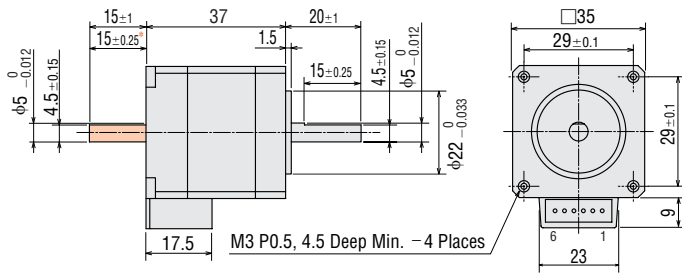

- **PK235PA** (Single Shaft) Mass 0.285 kg
- **PK235PB** (Double Shaft) Mass 0.285 kg

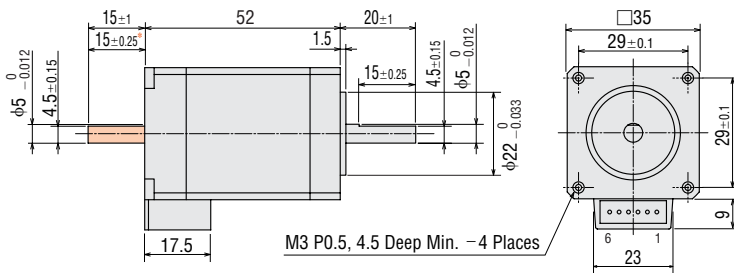

*15±0.25 indicates the length of milling on motor shaft.

●These dimensions are for double shaft models. For single shaft, ignore the colored areas.

Applicable Connector

The following housing and contacts must be purchased separately.
 Housing: 51103-0600 (MOLEX) or 51102-0600 (MOLEX)
 Contact: 50351-8XXX (MOLEX)

Speed-Torque Characteristics fs: Maximum Starting Pulse Rate

PK233PB Bipolar (Series)

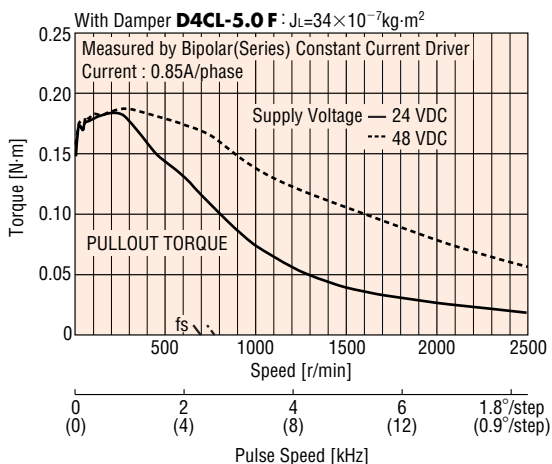

PK233PB Unipolar

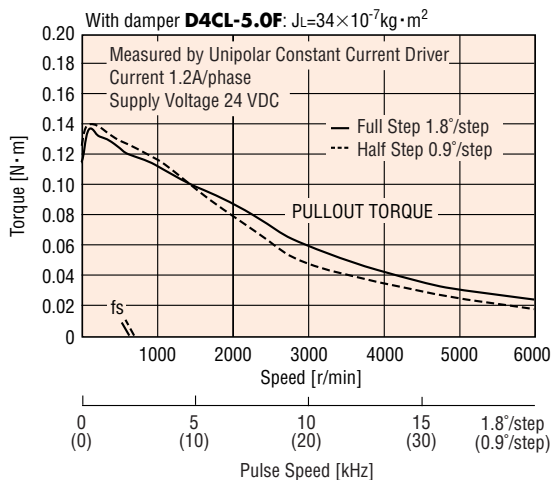

PK235PB Bipolar (Series)

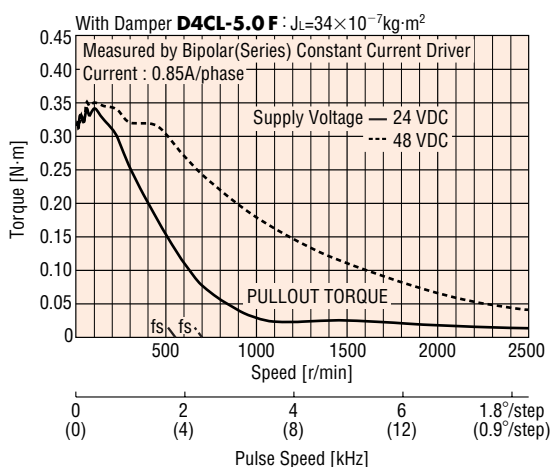

PK235PB Unipolar

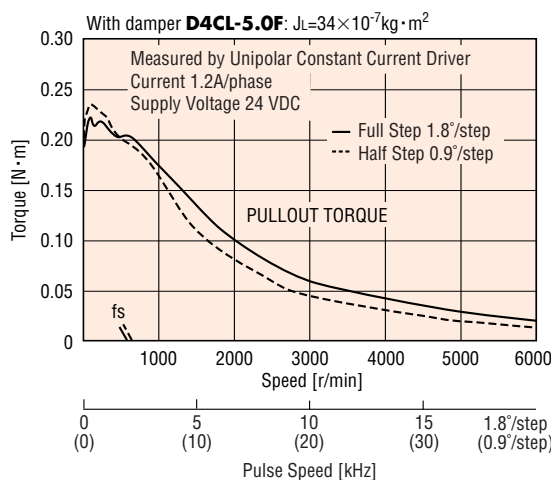

Optional Cable (Sold separately)

These connector cables make it easy to connect the **P** type motor. The crimped connectors eliminate the need for assembly. There are two cable lengths to choose from.

Model	Cable Length (mm)	Number of Leads	Leads Specifications	
			UL Style No.	AWG No.
LC2U06B	600	6 Leads	3265	24
LC2U10B	1000			



Standard Type

42mm

Step Angle 1.8°



Specifications

Model	Connection Type	Holding Torque	Current per Phase	Voltage	Resistance per Phase	Inductance	Rotor Inertia J	Lead Wires (Pin)	Connection Diagram (see page B-197)
Single Shaft Double Shaft		N·m	A/phase	V DC	Ω/phase	mH/phase	kg·m ²		
PK243-01A	Bipolar (Series)	0.2	0.67	5.6	8.4	10	35×10 ⁻⁷	6	[3]
PK243-01B	Unipolar	0.16	0.95	4	4.2	2.5			[2]
PK243-02A	Bipolar (Series)	0.2	0.28	13	48	60	35×10 ⁻⁷	6	[3]
PK243-02B	Unipolar	0.16	0.4	9.6	24	15			[2]
PK243-03A	Bipolar (Series)	0.2	0.22	17	77	84	35×10 ⁻⁷	6	[3]
PK243-03B	Unipolar	0.16	0.31	12	38.5	21			[2]
PK244-01A	Bipolar (Series)	0.33	0.85	5.6	6.6	12.8	54×10 ⁻⁷	6	[3]
PK244-01B	Unipolar	0.26	1.2	4	3.3	3.2			[2]
PK244-02A	Bipolar (Series)	0.33	0.57	8.6	15	26.8	54×10 ⁻⁷	6	[3]
PK244-02B	Unipolar	0.26	0.8	6	7.5	6.7			[2]
PK244-03A	Bipolar (Series)	0.33	0.28	17	60	120	54×10 ⁻⁷	6	[3]
PK244-03B	Unipolar	0.26	0.4	12	30	30			[2]
PK245-01A	Bipolar (Series)	0.43	0.85	5.6	6.6	11.2	68×10 ⁻⁷	6	[3]
PK245-01B	Unipolar	0.32	1.2	4	3.3	2.8			[2]
PK245-02A	Bipolar (Series)	0.43	0.57	8.6	15	28.4	68×10 ⁻⁷	6	[3]
PK245-02B	Unipolar	0.32	0.8	6	7.5	7.1			[2]
PK245-03A	Bipolar (Series)	0.43	0.28	17	60	100	68×10 ⁻⁷	6	[3]
PK245-03B	Unipolar	0.32	0.4	12	30	25			[2]

●Degree of Protection: IP30

Dimensions unit: mm

- PK243-0□A (Single Shaft) Mass 0.21 kg
- PK243-0□B (Double Shaft) Mass 0.21 kg

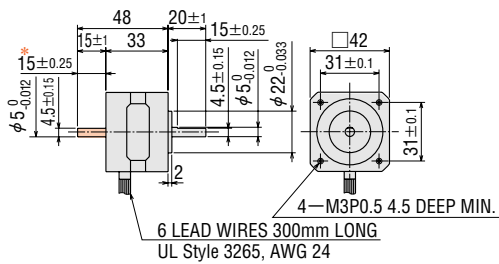

- PK245-0□A (Single Shaft) Mass 0.35 kg
- PK245-0□B (Double Shaft) Mass 0.35 kg

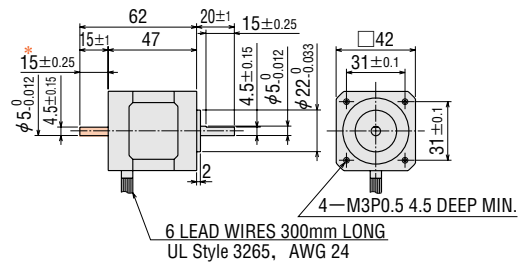

- PK244-0□A (Single Shaft) Mass 0.27 kg
- PK244-0□B (Double Shaft) Mass 0.27 kg

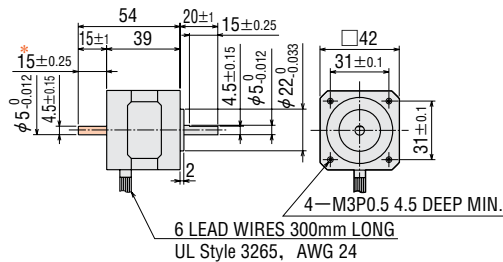

*15±0.25 indicates the length of milling on motor shaft.

●These dimensions are for double shaft models. For single shaft, ignore the colored areas.

Speed-Torque Characteristics fs: Maximum Starting Pulse Rate

● **PK243-01B** Bipolar (Series)

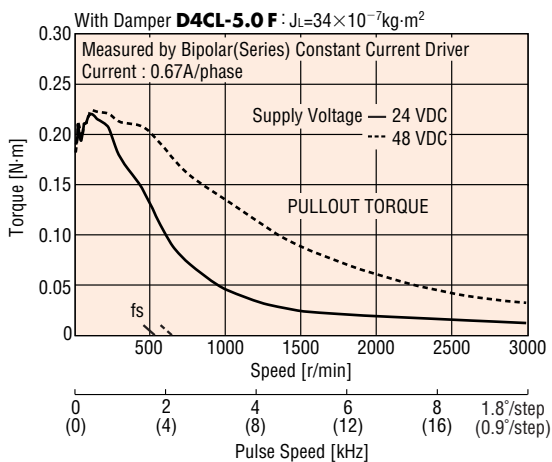

● **PK243-01B** Unipolar

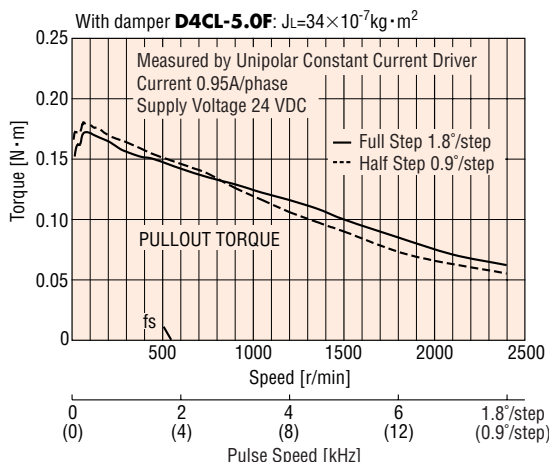

● **PK243-02B** Bipolar (Series)

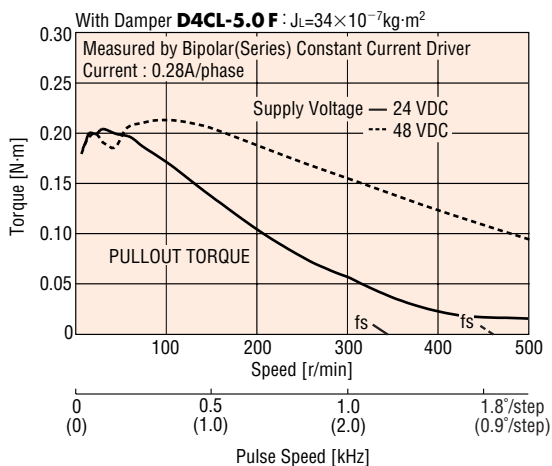

● **PK243-02B** Unipolar

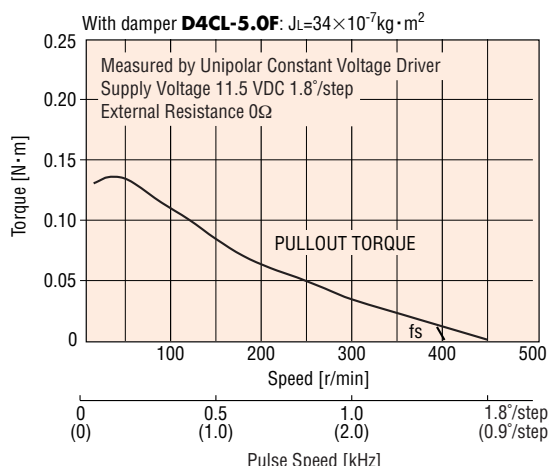

● **PK243-03B** Bipolar (Series)

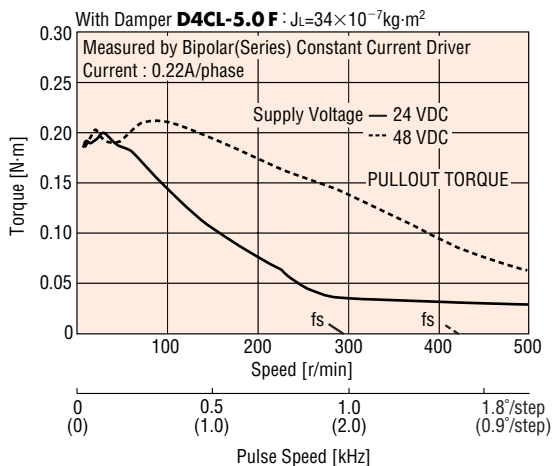

● **PK243-03B** Unipolar

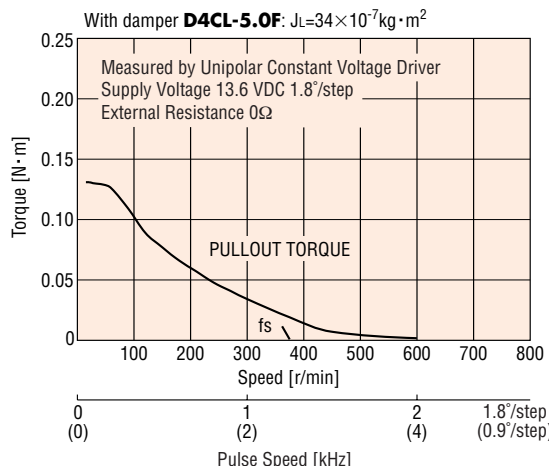

Speed-Torque Characteristics fs: Maximum Starting Pulse Rate

PK244-01B Bipolar (Series)

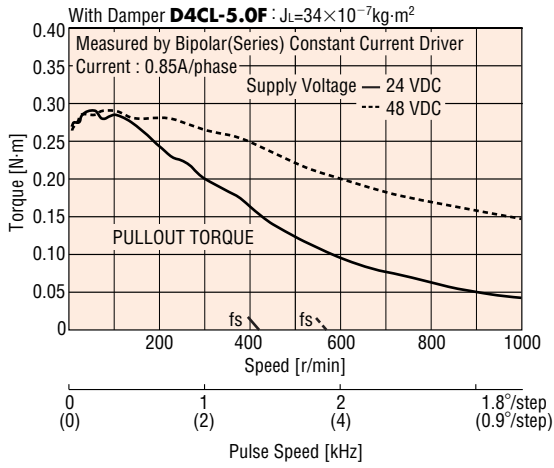

PK244-01B Unipolar

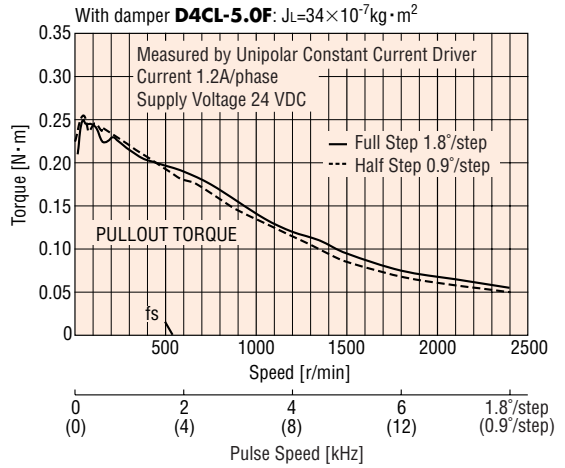

PK244-02B Bipolar (Series)

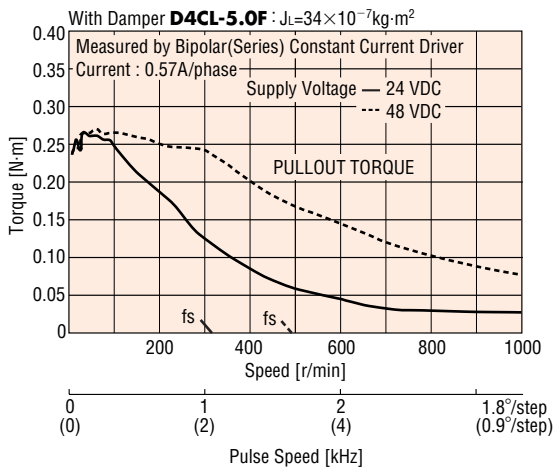

PK244-02B Unipolar

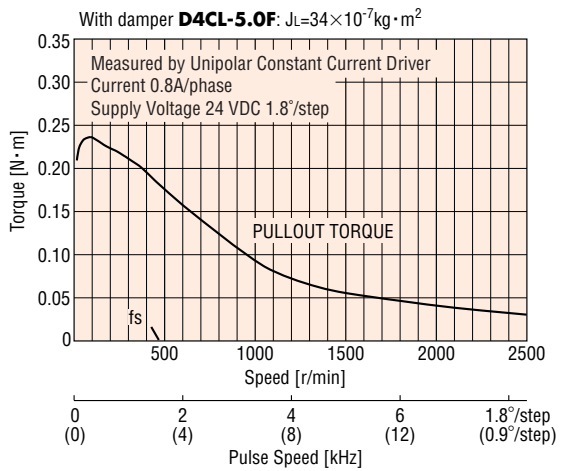

PK244-03B Unipolar

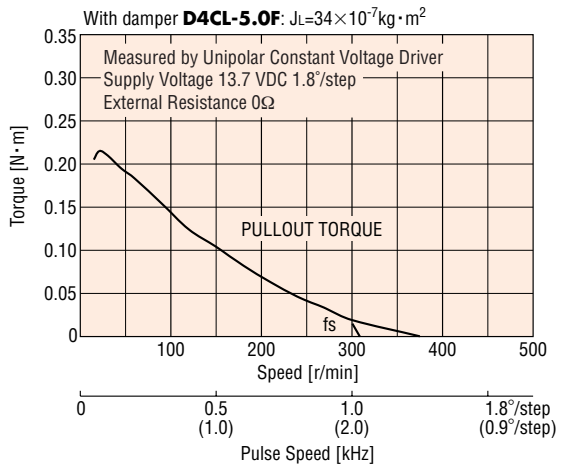

● **PK245-01B** Bipolar (Series)

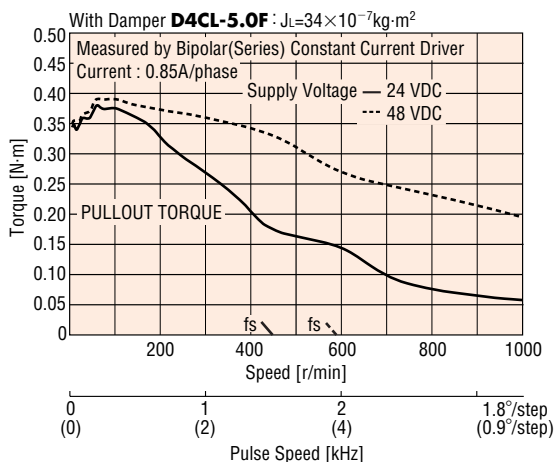

● **PK245-01B** Unipolar

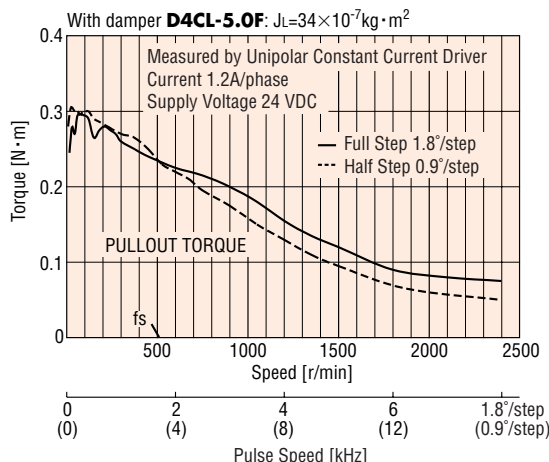

● **PK245-02B** Bipolar (Series)

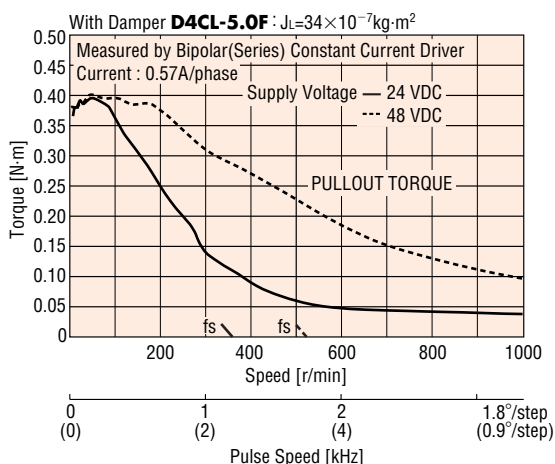

● **PK245-02B** Unipolar

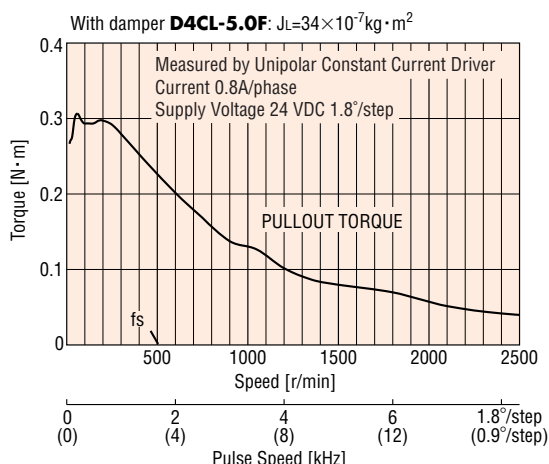

● **PK245-03B** Unipolar

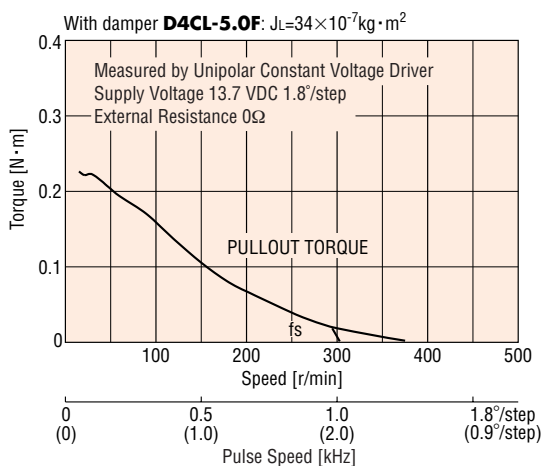

P Type (High Response)

42mm

Step Angle 1.8°

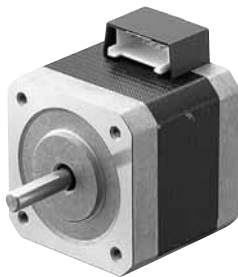

Specifications

Model	Connection Type	Holding Torque	Current per Phase	Voltage	Resistance per Phase	Inductance	Rotor Inertia J	Lead Wires (Pin)	Connection Diagram (see page B-197)
		N·m	A/phase	V DC	Ω/phase	mH/phase	kg·m ²		
PK244PA	Bipolar (Series)	0.48	0.85	6.8	8	15.6	57×10 ⁻⁷	6	[3]
PK244PB	Unipolar	0.39	1.2	4.8	4	3.9			[2]
PK246PA	Bipolar (Series)	0.93	0.85	10	12	26	114×10 ⁻⁷	6	[3]
PK246PB	Unipolar	0.75	1.2	7.2	6	6.5			[2]

●Degree of Protection: IP30

Dimensions unit: mm

- PK244PA (Single Shaft) Mass 0.3 kg
- PK244PB (Double Shaft) Mass 0.3 kg

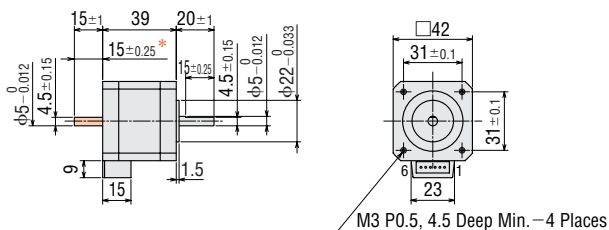

- PK246PA (Single Shaft) Mass 0.5 kg
- PK246PB (Double Shaft) Mass 0.5 kg

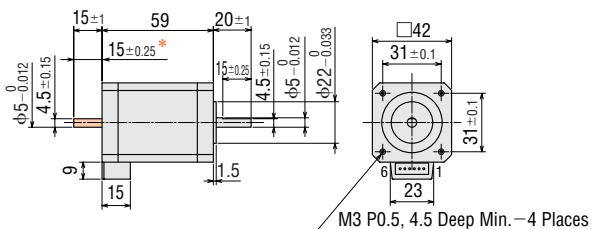

- *15±0.25 indicates the length of milling on motor shaft.
- These dimensions are for double shaft models. For single shaft, ignore the colored areas.

Applicable Connector

The following housing and contacts must be purchased separately.
 Housing: 51103-0600 (MOLEX) or 51102-0600 (MOLEX)
 Contact: 50351-8XXX (MOLEX)

Speed-Torque Characteristics fs: Maximum Starting Pulse Rate

PK244PB Bipolar (Series)

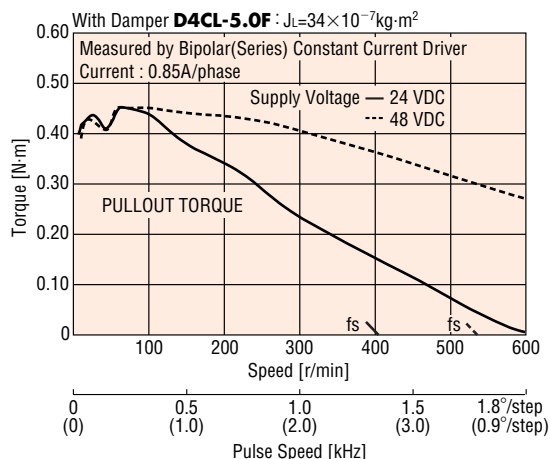

PK244PB Unipolar

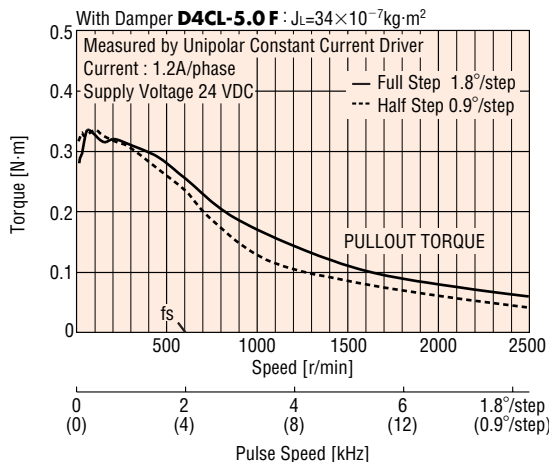

PK246PB Bipolar (Series)

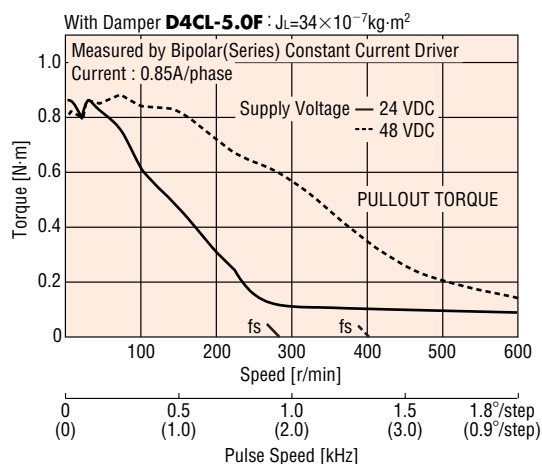

PK246PB Unipolar

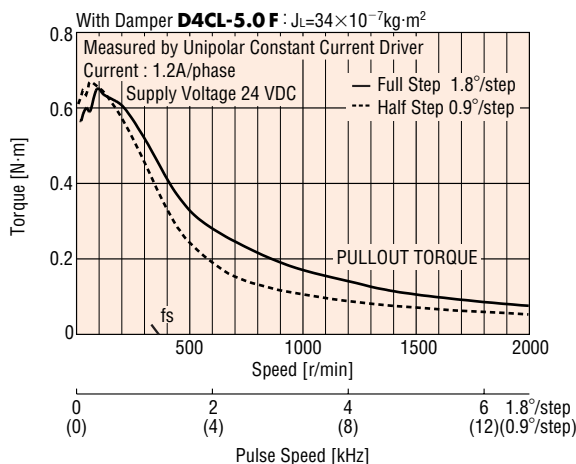

Optional Cable (Sold separately)

These connector cables make it easy to connect the **P** type motor. The crimped connectors eliminate the need for assembly. There are two cable lengths to choose from.

Model	Cable Length (mm)	Number of Leads	Leads Specifications	
			UL Style No.	AWG No.
LC2U06B	600	6 Leads	3265	24
LC2U10B	1000			



M Type (High Resolution)

42mm

Step Angle 0.9°



Specifications

Model	Connection Type	Holding Torque	Current per Phase	Voltage	Resistance per Phase	Inductance	Rotor Inertia J	Lead Wires (Pin)	Connection Diagram (see page B-197)
Single Shaft Double Shaft		N·m	A/phase	V DC	Ω/phase	mH/phase	kg·m ²		
PK243M-01A	Bipolar (Series)	0.2	0.67	5.6	8.4	15.2	35×10 ⁻⁷	6	[3]
PK243M-01B	Unipolar	0.16	0.95	4	4.2	3.8			[2]
PK243M-02A	Bipolar (Series)	0.2	0.42	8.4	20	38.8	35×10 ⁻⁷	6	[3]
PK243M-02B	Unipolar	0.16	0.6	6	10	9.7			[2]
PK243M-03A	Bipolar (Series)	0.2	0.22	17	77	136	35×10 ⁻⁷	6	[3]
PK243M-03B	Unipolar	0.16	0.31	12	38.5	34			[2]
PK244M-01A	Bipolar (Series)	0.31	0.85	5.6	6.6	17.2	54×10 ⁻⁷	6	[3]
PK244M-01B	Unipolar	0.26	1.2	4	3.3	4.3			[2]
PK244M-02A	Bipolar (Series)	0.31	0.57	8.6	15	38.8	54×10 ⁻⁷	6	[3]
PK244M-02B	Unipolar	0.26	0.8	6	7.5	9.7			[2]
PK244M-03A	Bipolar (Series)	0.31	0.28	17	60	152	54×10 ⁻⁷	6	[3]
PK244M-03B	Unipolar	0.26	0.4	12	30	38			[2]
PK245M-01A	Bipolar (Series)	0.38	0.85	5.6	6.6	15.6	68×10 ⁻⁷	6	[3]
PK245M-01B	Unipolar	0.32	1.2	4	3.3	3.9			[2]
PK245M-02A	Bipolar (Series)	0.38	0.57	8.6	15	39.6	68×10 ⁻⁷	6	[3]
PK245M-02B	Unipolar	0.32	0.8	6	7.5	9.9			[2]
PK245M-03A	Bipolar (Series)	0.38	0.28	17	60	128	68×10 ⁻⁷	6	[3]
PK245M-03B	Unipolar	0.32	0.4	12	30	32			[2]

●Degree of Protection: IP30

Dimensions unit: mm

- PK243M-0□A (Single Shaft) Mass 0.24 kg
- PK243M-0□B (Double Shaft) Mass 0.24 kg

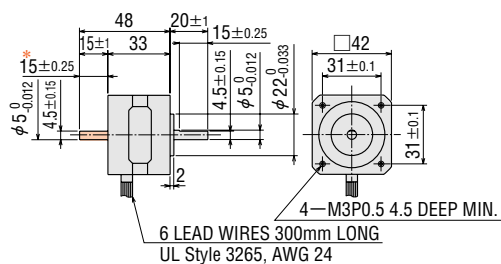

- PK245M-0□A (Single Shaft) Mass 0.37 kg
- PK245M-0□B (Double Shaft) Mass 0.37 kg

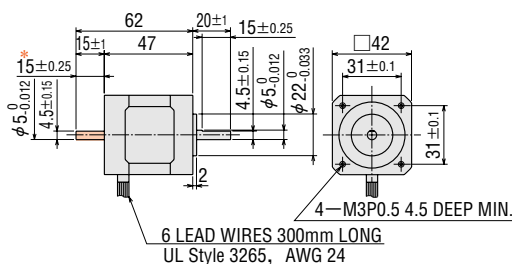

- PK244M-0□A (Single Shaft) Mass 0.3 kg
- PK244M-0□B (Double Shaft) Mass 0.3 kg

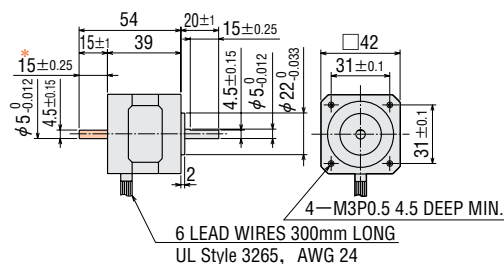

*15±0.25 indicates the length of milling on motor shaft.

●These dimensions are for double shaft models. For single shaft, ignore the colored areas.

Speed-Torque Characteristics fs: Maximum Starting Pulse Rate

● **PK243M-01B** Bipolar (Series)

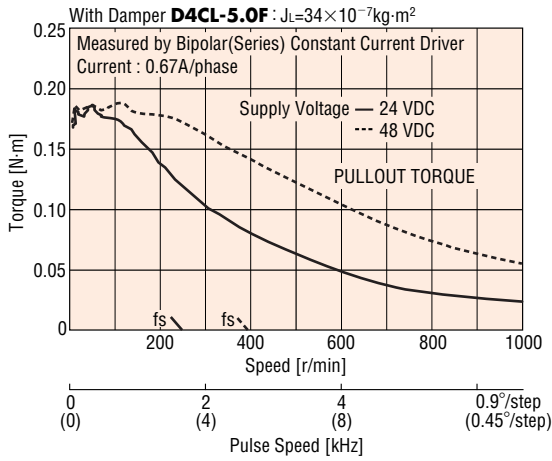

● **PK243M-01B** Unipolar

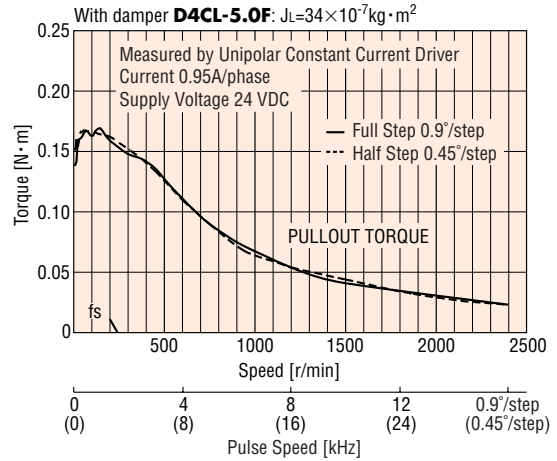

● **PK243M-02B** Bipolar (Series)

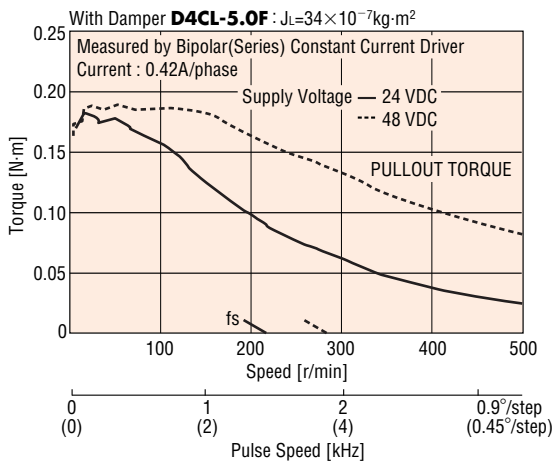

● **PK243M-02B** Unipolar

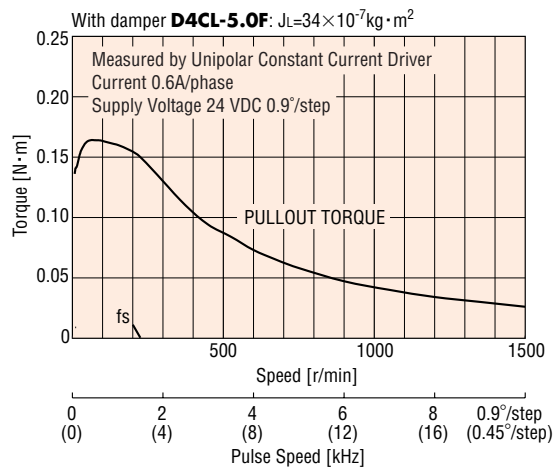

● **PK243M-03B** Bipolar (Series)

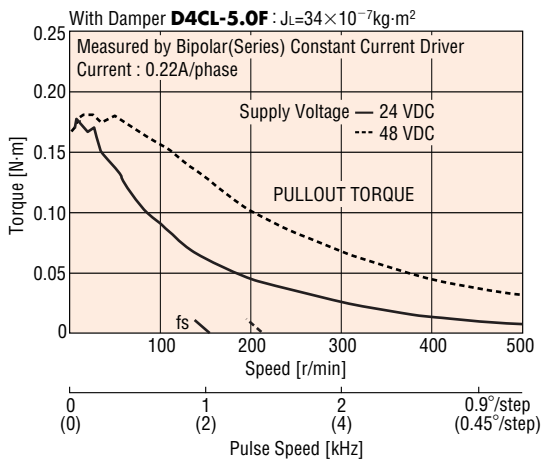

● **PK243M-03B** Unipolar

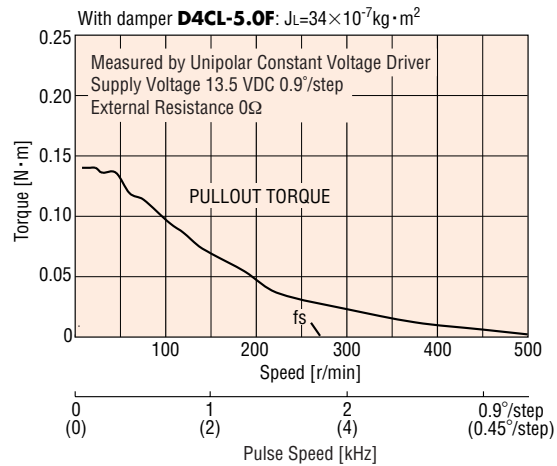

Speed-Torque Characteristics

fs: Maximum Starting Pulse Rate

● **PK244M-01B** Bipolar (Series)

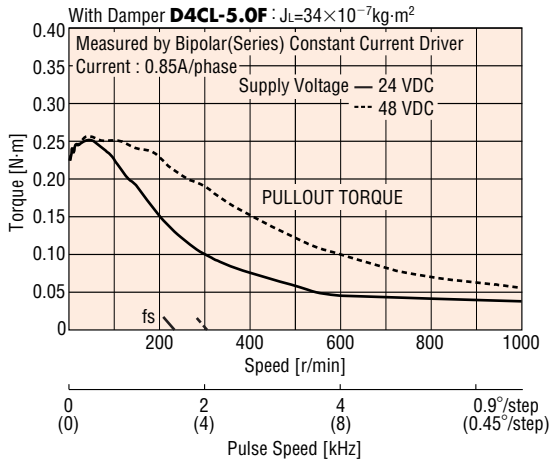

● **PK244M-01B** Unipolar

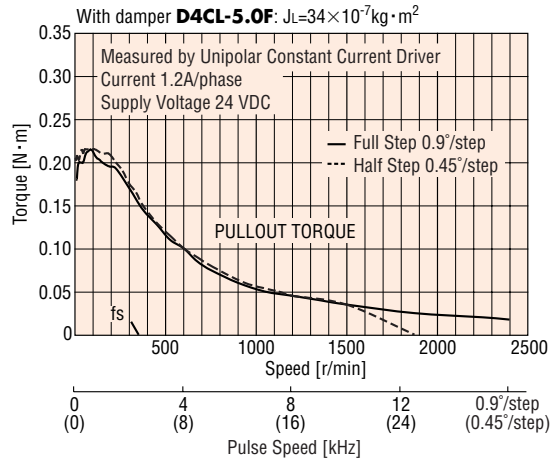

● **PK244M-02B** Bipolar (Series)

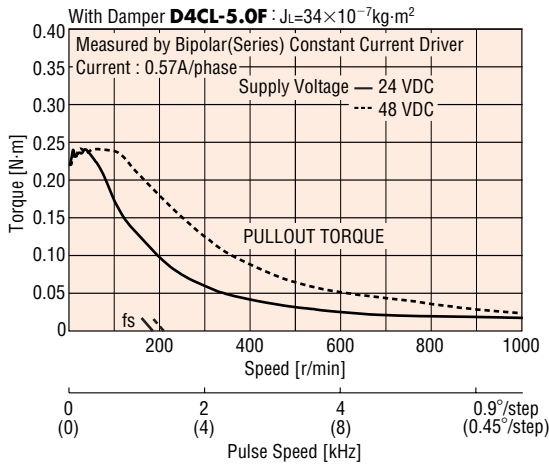

● **PK244M-02B** Unipolar

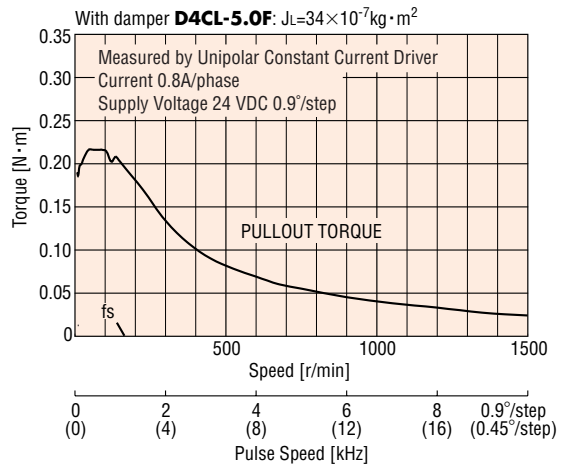

● **PK244M-03B** Unipolar

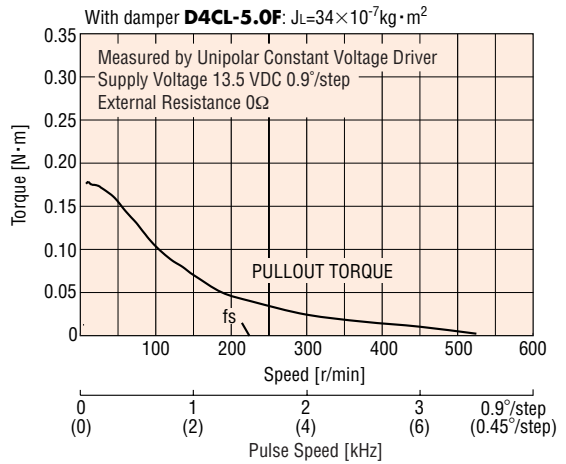

QSTEP

RK
5-Phase with AC Driver

CSK
5-Phase with DC Driver

PMC

NanoStep RK

5-Phase Stepping Motors

2-Phase with DC Driver

CSK

2-Phase Stepping Motors

Controller

Accessories

● **PK245M-01B** Bipolar (Series)

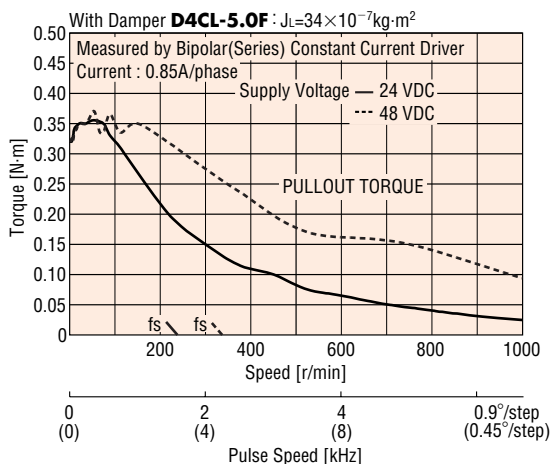

● **PK245M-01B** Unipolar

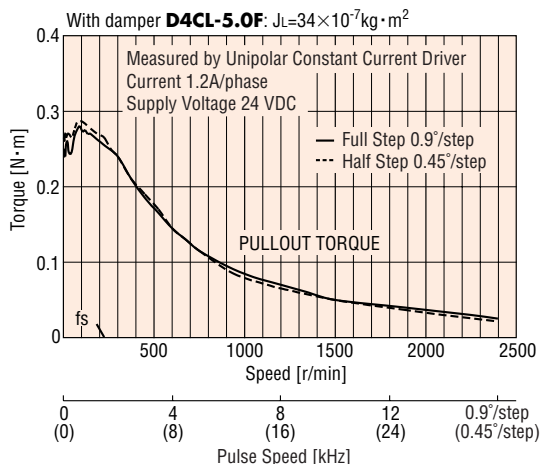

● **PK245M-02B** Bipolar (Series)

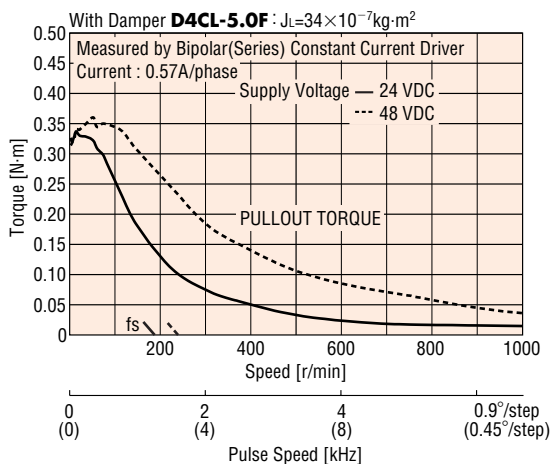

● **PK245M-02B** Unipolar

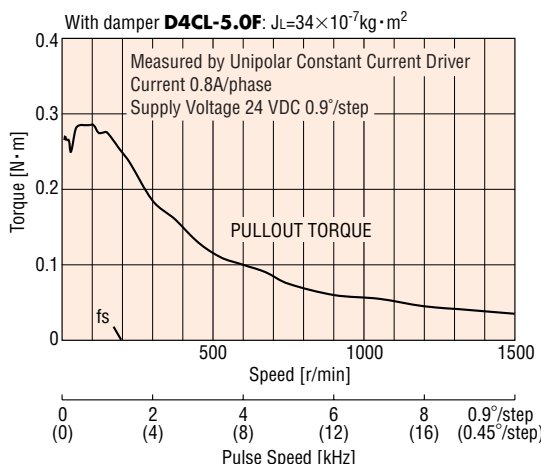

● **PK245M-03B** Unipolar

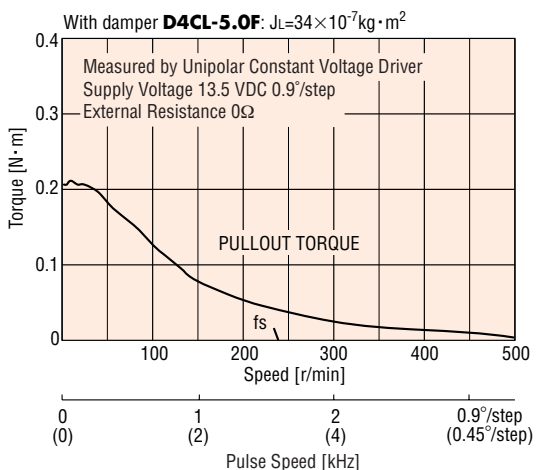

SH Geared Type

42mm



Specifications

● Motor Specifications

Model	Connection Type	Current per Phase	Voltage	Resistance per Phase	Inductance	Rotor Inertia J	Lead Wires (Pin)	Connection Diagram
Single Shaft Double Shaft		A/phase	V DC	Ω/phase	mH/phase	kg·m ²		(see page B-197)
PK243A1-SG □	Bipolar (Series)	0.67	5.6	8.4	10	35×10 ⁻⁷	6	3
PK243B1-SG □	Unipolar	0.95	4.0	4.2	2.5			2

*Enter the gear ratio in the box (□) within the model name.

●Degree of Protection: IP30

● Gearmotor Specifications

Model	Gear Ratio	Holding Torque	Step Angle	Permissible Speed	Permissible Thrust Load	Permissible Overhung Load
Single Shaft Double Shaft		N·m		r/min	N	(at 10mm from shaft end) N
PK243A1-SG3.6 PK243B1-SG3.6	1:3.6	0.2	0.5°	500	15	20
PK243A1-SG7.2 PK243B1-SG7.2	1:7.2	0.4	0.25°	250	15	20
PK243A1-SG9 PK243B1-SG9	1:9	0.5	0.2°	200	15	20
PK243A1-SG10 PK243B1-SG10	1:10	0.56	0.18°	180	15	20
PK243A1-SG18 PK243B1-SG18	1:18	0.8	0.1°	100	15	20
PK243A1-SG36 PK243B1-SG36	1:36	0.8	0.05°	50	15	20

■ Dimensions unit: mm

- **PK243A1-SG**□ (Single Shaft) Mass 0.35 kg
- **PK243B1-SG**□ (Double Shaft) Mass 0.35 kg

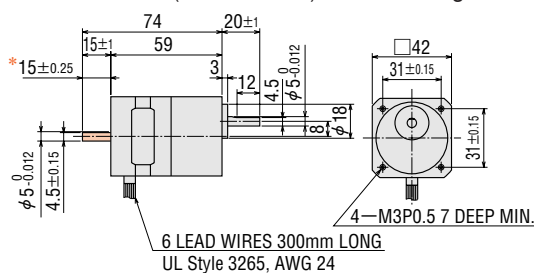

Mounting Screws (included)
M3 P0.5 10mm long: 4 pieces

*15±0.25 indicates the length of milling on motor shaft.

● This dimension is for double shaft models. For single shaft, ignore the colored area.

Speed-Torque Characteristics

fs: Maximum Starting Pulse Rate

●PK243B1-SG □ Bipolar (Series) 24 VDC

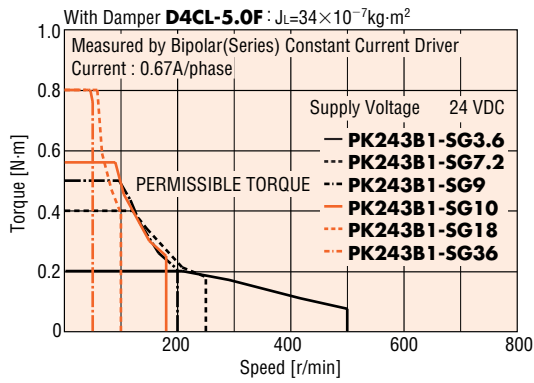

●PK243B1-SG □ Unipolar

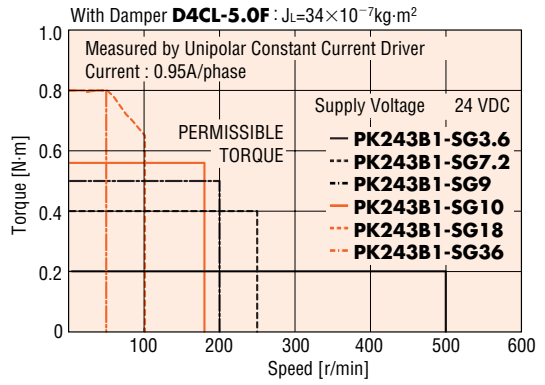

●PK243B1-SG □ Bipolar (Series) 48 VDC

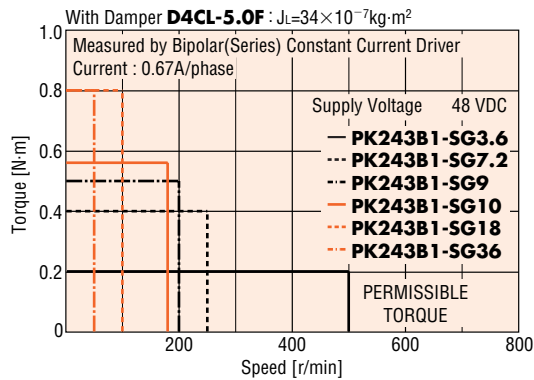

Standard Type

56.4mm

Step Angle 1.8°



Specifications

Model	Connection Type	Holding Torque N·m	Current per Phase A/phase	Voltage V DC	Resistance per Phase Ω/phase	Inductance mH/phase	Rotor Inertia J kg·m ²	Lead Wires (Pin)	Connection Diagram (see page B-197)
PK264-01A	Bipolar (Series)	0.48	0.71	8.1	11.4	21.6	120×10 ⁻⁷	6	[3]
PK264-01B	Unipolar	0.39	1	5.7	5.7	5.4			[2]
PK264-02A	Bipolar (Series)	0.48	1.4	3.9	2.8	5.6	120×10 ⁻⁷	6	[3]
PK264-02B	Unipolar	0.39	2	2.8	1.4	1.4			[2]
PK264-03A	Bipolar (Series)	0.48	2.1	2.6	1.26	2.4	120×10 ⁻⁷	6	[3]
PK264-03B	Unipolar	0.39	3	1.9	0.63	0.6			[2]
PK264-E2.0A	Bipolar (Parallel)	0.48	2.8	1.96	0.7	1.4	120×10 ⁻⁷	8	[6]
PK264-E2.0B	Bipolar (Series)	0.48	1.4	3.9	2.8	5.6			[5]
	Unipolar	0.39	2	2.8	1.4	1.4			[4]
PK266-01A	Bipolar (Series)	1.17	0.71	11	14.8	40	300×10 ⁻⁷	6	[3]
PK266-01B	Unipolar	0.9	1	7.4	7.4	10			[2]
PK266-02A	Bipolar (Series)	1.17	1.4	5	3.6	10	300×10 ⁻⁷	6	[3]
PK266-02B	Unipolar	0.9	2	3.6	1.8	2.5			[2]
PK266-03A	Bipolar (Series)	1.17	2.1	3.2	1.5	4.4	300×10 ⁻⁷	6	[3]
PK266-03B	Unipolar	0.9	3	2.3	0.75	1.1			[2]
PK266-E2.0A	Bipolar (Parallel)	1.17	2.8	2.52	0.9	2.5	300×10 ⁻⁷	8	[6]
PK266-E2.0B	Bipolar (Series)	1.17	1.4	5	3.6	10			[5]
	Unipolar	0.9	2	3.6	1.8	2.5			[4]
PK268-01A	Bipolar (Series)	1.75	0.71	12	17.2	56	480×10 ⁻⁷	6	[3]
PK268-01B	Unipolar	1.35	1	8.6	8.6	14			[2]
PK268-02A	Bipolar (Series)	1.75	1.4	6.3	4.5	14.4	480×10 ⁻⁷	6	[3]
PK268-02B	Unipolar	1.35	2	4.5	2.25	3.6			[2]
PK268-03A	Bipolar (Series)	1.75	2.1	4.2	2	6.4	480×10 ⁻⁷	6	[3]
PK268-03B	Unipolar	1.35	3	3	1	1.6			[2]
PK268-E2.0A	Bipolar (Parallel)	1.75	2.8	3.16	1.13	3.6	480×10 ⁻⁷	8	[6]
PK268-E2.0B	Bipolar (Series)	1.75	1.4	6.3	4.5	14.4			[5]
	Unipolar	1.35	2	4.5	2.25	3.6			[4]

●Degree of Protection: IP30

QSTEP

RK

CSK

PMC

NanoStep

RFK

5-Phase

Stepping

Motors

2-Phase

with DC Driver

CSK

2-Phase

Stepping

Motors

Controller

Accessories

■ Dimensions unit: mm

- **PK264-0□A, PK264-E2.0A** (Single Shaft) Mass 0.45 kg
- **PK264-0□B, PK264-E2.0B** (Double Shaft) Mass 0.45 kg

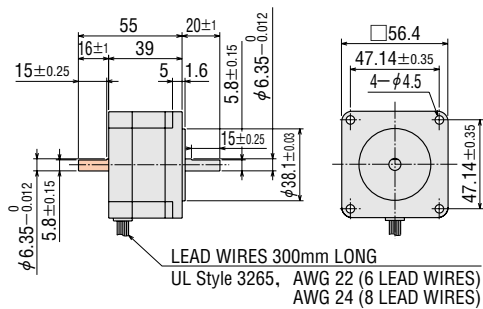

- **PK266-0□A, PK266-E2.0A** (Single Shaft) Mass 0.7 kg
- **PK266-0□B, PK266-E2.0B** (Double Shaft) Mass 0.7 kg

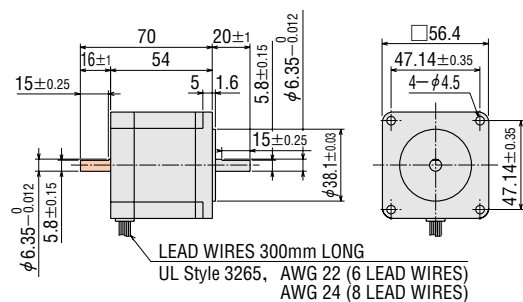

- **PK268-0□A, PK268-E2.0A** (Single Shaft) Mass 1 kg
- **PK268-0□B, PK268-E2.0B** (Double Shaft) Mass 1 kg

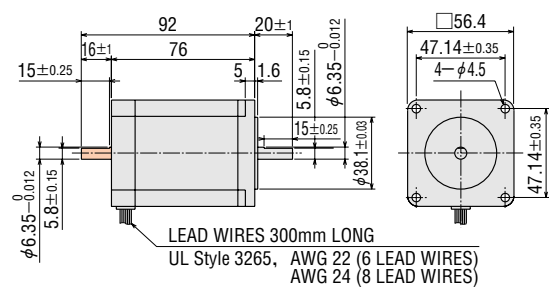

● These dimensions are for double shaft models. For single shaft, ignore the colored areas.

Speed-Torque Characteristics fs: Maximum Starting Pulse Rate

● **PK264-01B** Bipolar (Series)

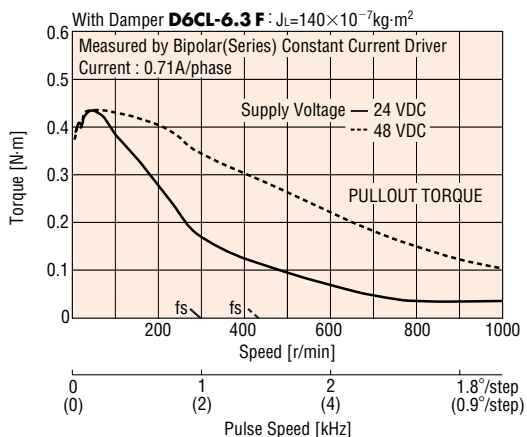

● **PK264-01B** Unipolar

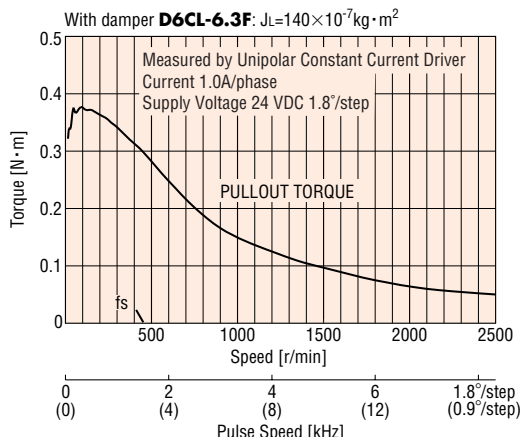

● **PK264-02B** Bipolar (Series)

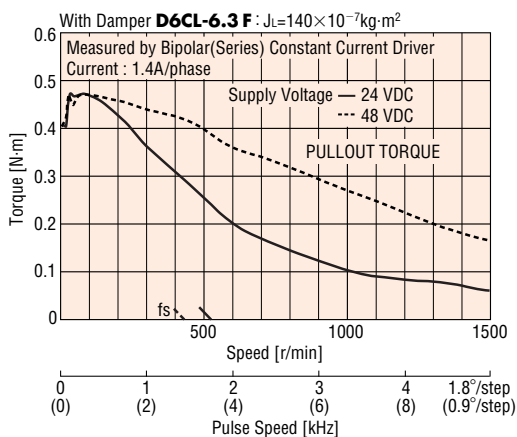

● **PK264-02B** Unipolar

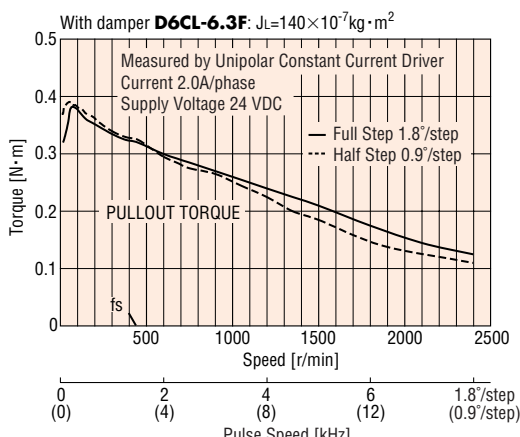

● **PK264-03B** Bipolar (Series)

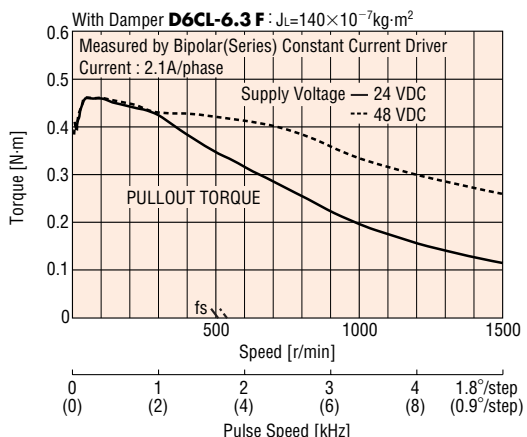

● **PK264-03B** Unipolar

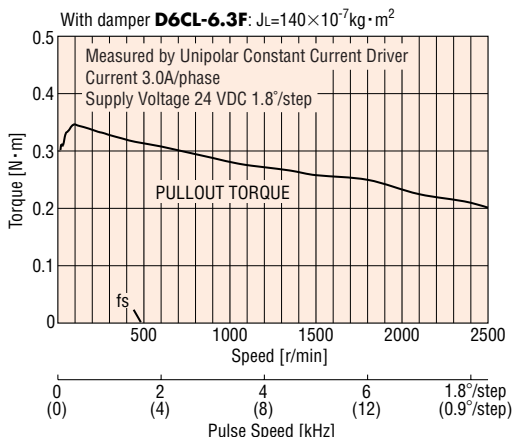

● **PK264-E2.0B** Bipolar (Parallel)

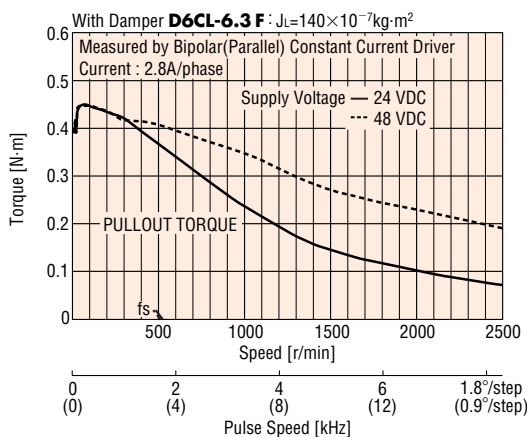

● **PK264-E2.0B** Bipolar (Series)

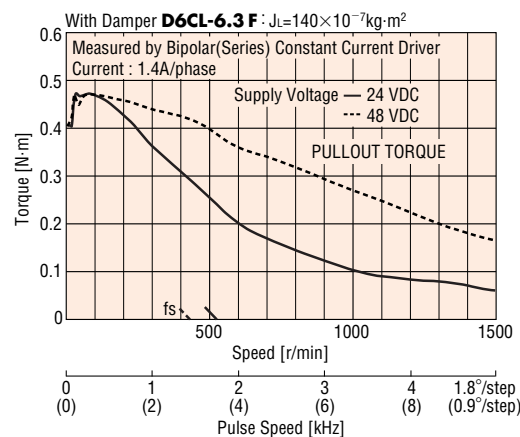

● **PK266-01B** Bipolar (Series)

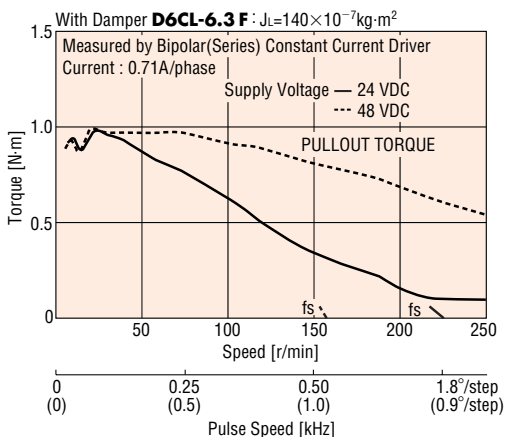

● **PK266-01B** Unipolar

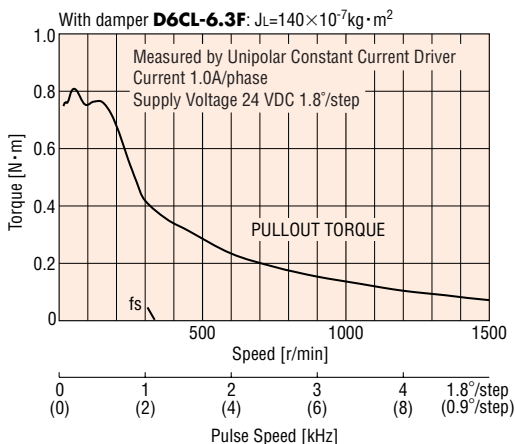

● **PK266-02B** Bipolar (Series)

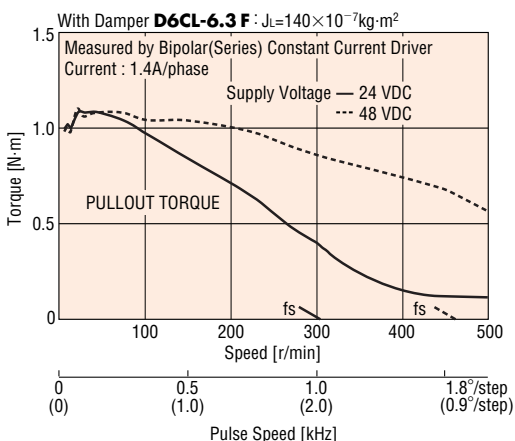

● **PK266-02B** Unipolar

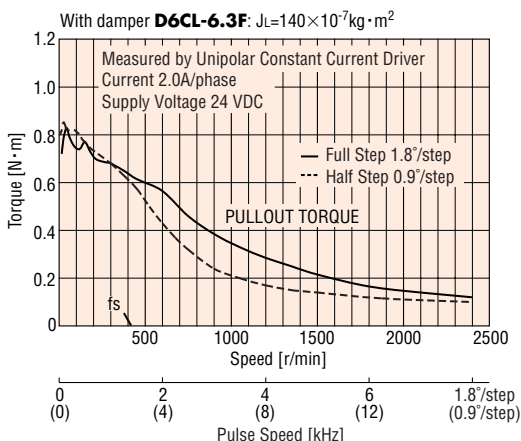

● **PK266-03B** Bipolar (Series)

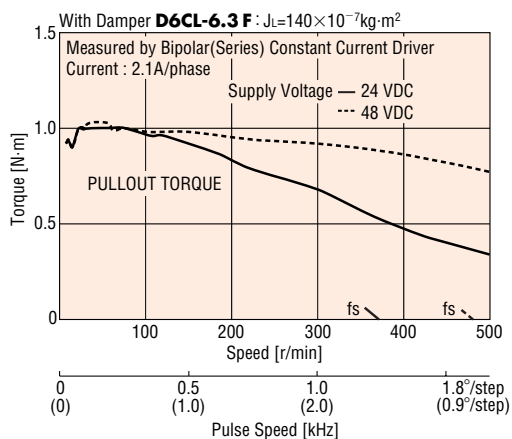

● **PK266-03B** Unipolar

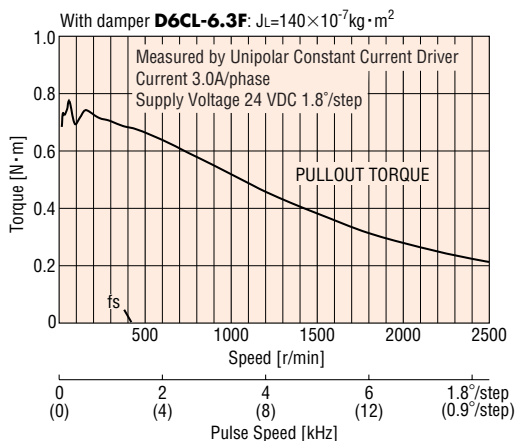

● **PK266-E2.0B** Bipolar (Parallel)

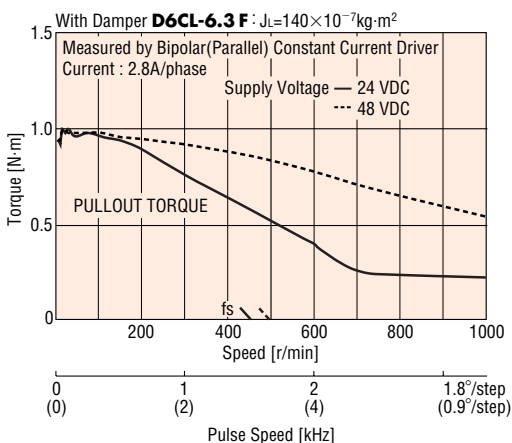

● **PK266-E2.0B** Bipolar (Series)

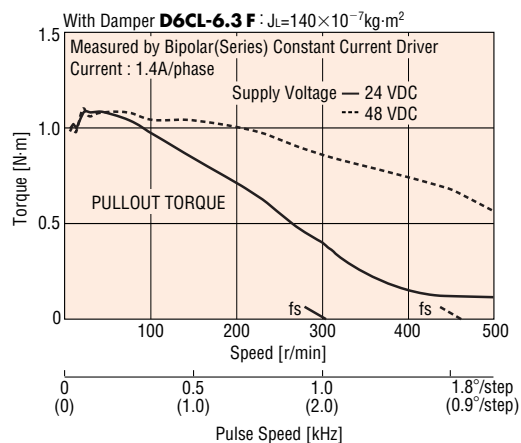

Speed-Torque Characteristics

fs: Maximum Starting Pulse Rate

PK268-01B Bipolar (Series)

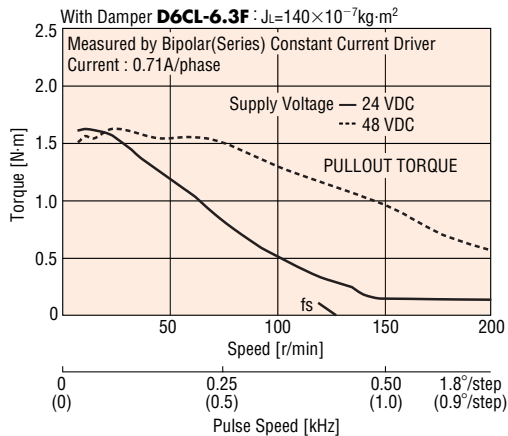

PK268-01B Unipolar

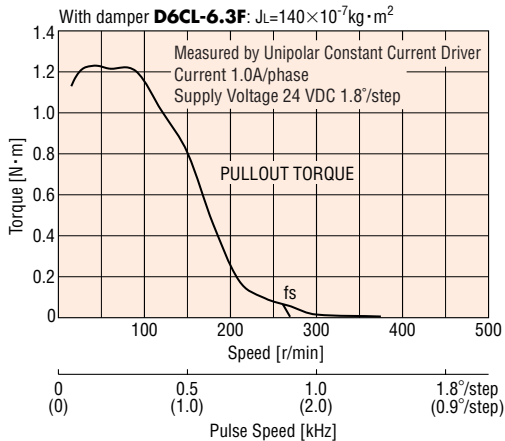

PK268-02B Bipolar (Series)

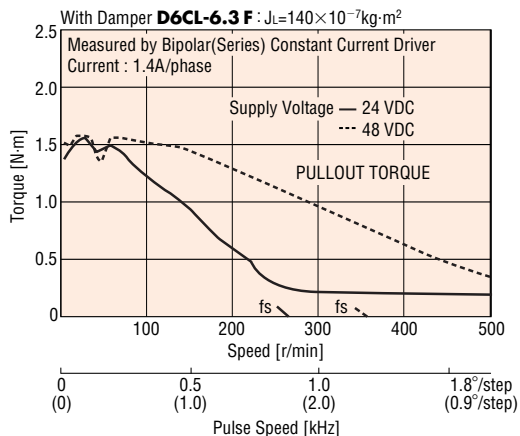

PK268-02B Unipolar

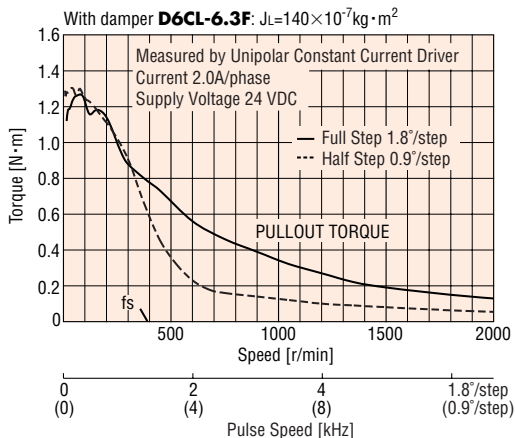

PK268-03B Bipolar (Series)

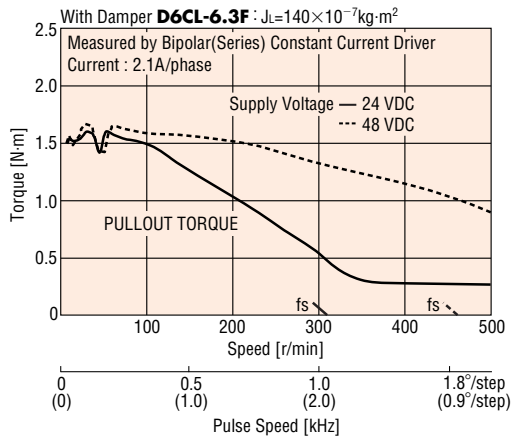

PK268-03B Unipolar

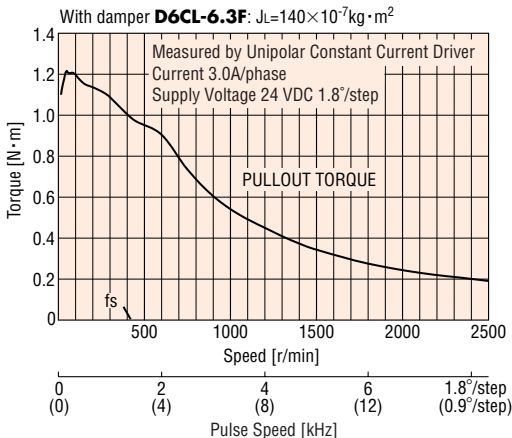

PK268-E2.0B Bipolar (Parallel)

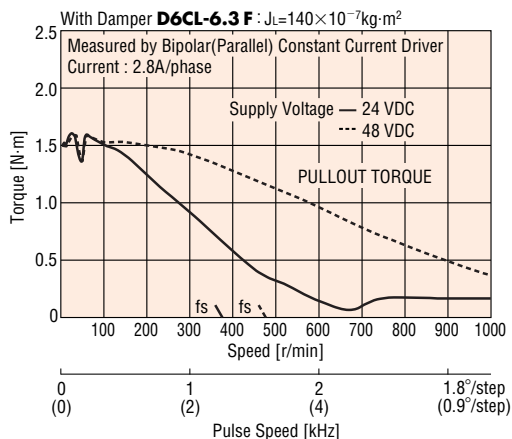

PK268-E2.0B Bipolar (Series)

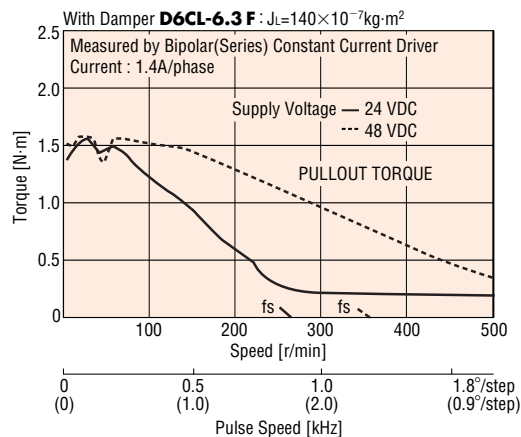



M Type (High Resolution Type)

 56.4mm

Step Angle 0.9°

Specifications

Model	Connection Type	Holding Torque	Current per Phase	Voltage	Resistance per Phase	Inductance	Rotor Inertia J	Lead Wires (Pin)	Connection Diagram (see page B-197)
		N·m	A/phase	V DC	Ω/phase	mH/phase	kg·m ²		
PK264M-01A	Bipolar (Series)	0.48	0.71	8.1	11.4	26	120×10 ⁻⁷	6	3
PK264M-01B	Unipolar	0.39	1	5.7	5.7	6.5			2
PK264M-02A	Bipolar (Series)	0.48	1.4	3.9	2.8	6.8	120×10 ⁻⁷	6	3
PK264M-02B	Unipolar	0.39	2	2.8	1.4	1.7			2
PK264M-03A	Bipolar (Series)	0.48	2.1	2.6	1.26	3	120×10 ⁻⁷	6	3
PK264M-03B	Unipolar	0.39	3	1.9	0.63	0.75			2
PK264M-E2.0A	Bipolar (Parallel)	0.48	2.8	1.96	0.7	1.7	120×10 ⁻⁷	8	6
PK264M-E2.0B	Bipolar (Series)	0.48	1.4	3.9	2.8	6.8			5
	Unipolar	0.39	2	2.8	1.4	1.7			4
PK266M-01A	Bipolar (Series)	1.17	0.71	11	14.8	50.8	300×10 ⁻⁷	6	3
PK266M-01B	Unipolar	0.9	1	7.4	7.4	12.7			2
PK266M-02A	Bipolar (Series)	1.17	1.4	5	3.6	12.8	300×10 ⁻⁷	6	3
PK266M-02B	Unipolar	0.9	2	3.6	1.8	3.2			2
PK266M-03A	Bipolar (Series)	1.17	2.1	3.2	1.5	5.8	300×10 ⁻⁷	6	3
PK266M-03B	Unipolar	0.9	3	2.3	0.75	1.45			2
PK266M-E2.0A	Bipolar (Parallel)	1.17	2.8	2.52	0.9	3.2	300×10 ⁻⁷	8	6
PK266M-E2.0B	Bipolar (Series)	1.17	1.4	5	3.6	12.8			5
	Unipolar	0.9	2	3.6	1.8	3.2			4
PK268M-01A	Bipolar (Series)	1.75	0.71	12	17.2	77.6	480×10 ⁻⁷	6	3
PK268M-01B	Unipolar	1.35	1	8.6	8.6	19.4			2
PK268M-02A	Bipolar (Series)	1.75	1.4	6.3	4.5	19.2	480×10 ⁻⁷	6	3
PK268M-02B	Unipolar	1.35	2	4.5	2.25	4.8			2
PK268M-03A	Bipolar (Series)	1.75	2.1	4.2	2	8.4	480×10 ⁻⁷	6	3
PK268M-03B	Unipolar	1.35	3	3	1	2.1			2
PK268M-E2.0A	Bipolar (Parallel)	1.75	2.8	3.16	1.13	4.8	480×10 ⁻⁷	8	6
PK268M-E2.0B	Bipolar (Series)	1.75	1.4	6.3	4.5	19.2			5
	Unipolar	1.35	2	4.5	2.25	4.8			4

●Degree of Protection: IP30

■ Dimensions unit: mm

- PK264M-0□A, PK264M-E2.0A (Single Shaft) Mass 0.45 kg
- PK264M-0□B, PK264M-E2.0B (Double Shaft) Mass 0.45 kg

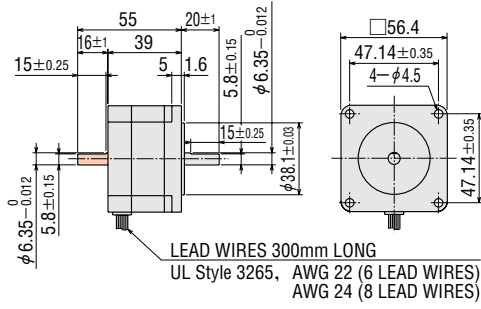

- PK266M-0□A, PK266M-E2.0A (Single Shaft) Mass 0.7 kg
- PK266M-0□B, PK266M-E2.0B (Double Shaft) Mass 0.7 kg

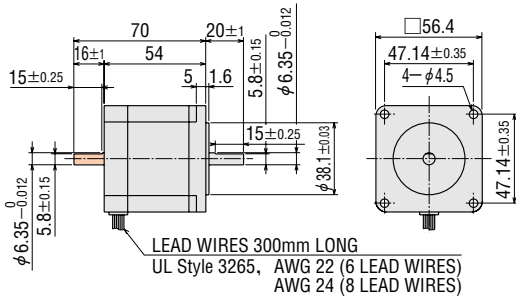

- PK268M-0□A, PK268M-E2.0A (Single Shaft) Mass 1 kg
- PK268M-0□B, PK268M-E2.0B (Double Shaft) Mass 1 kg

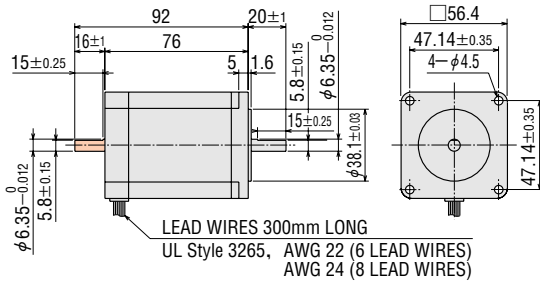

● These dimensions are for double shaft models. For single shaft, ignore the colored areas.

Speed-Torque Characteristics

fs: Maximum Starting Pulse Rate

PK264M-01B Bipolar (Series)

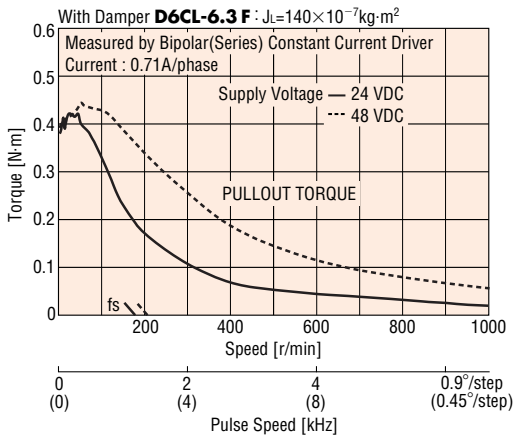

PK264M-01B Unipolar

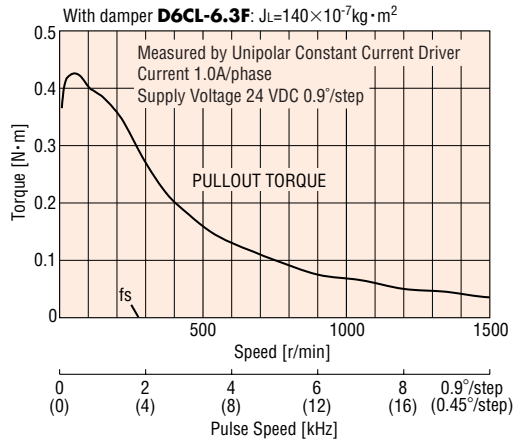

PK264M-02B Bipolar (Series)

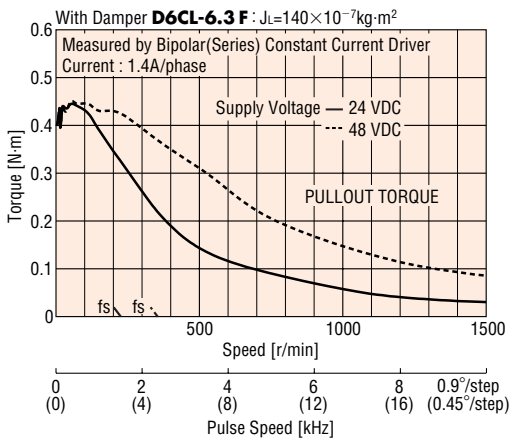

PK264M-02B Unipolar

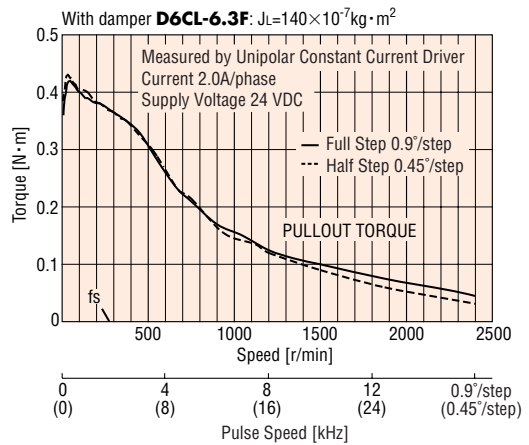

PK264M-03B Bipolar (Series)

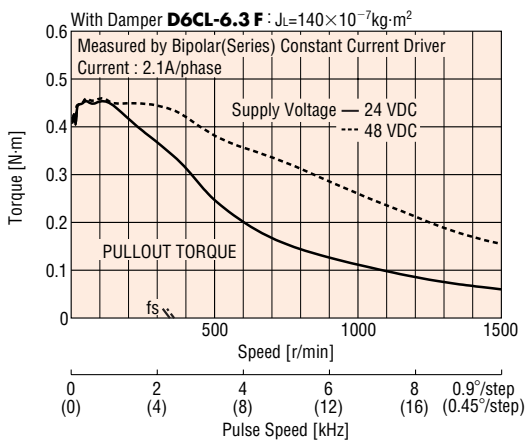

PK264M-03B Unipolar

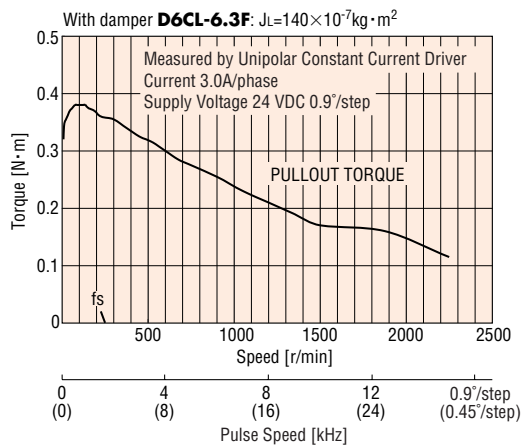

PK264M-E2.0B Bipolar (Parallel)

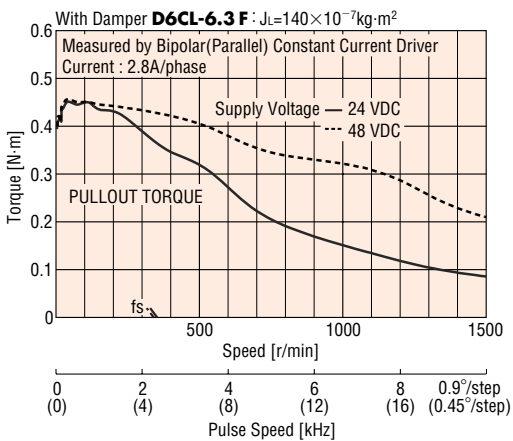

PK264M-E2.0B Bipolar (Series)

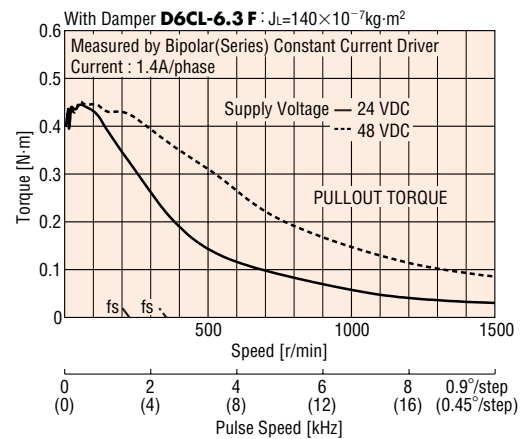

Speed-Torque Characteristics

fs: Maximum Starting Pulse Rate

PK266M-01B Bipolar (Series)

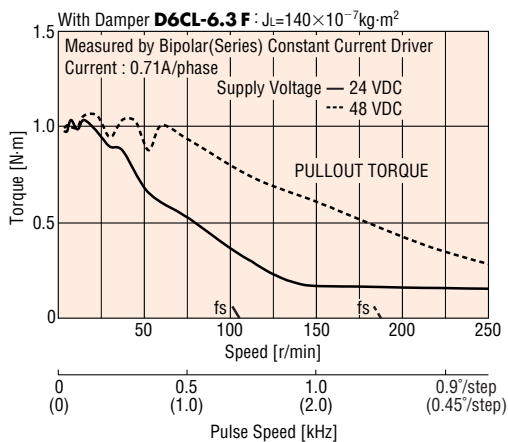

PK266M-01B Unipolar

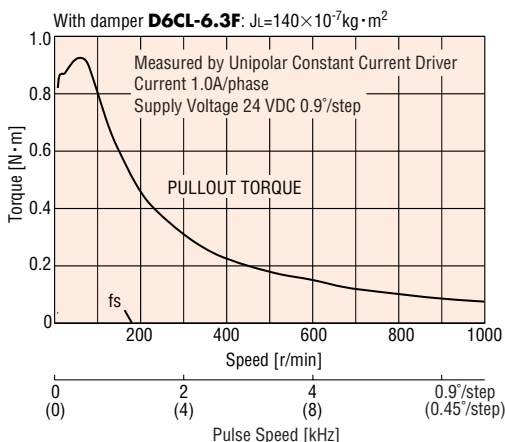

PK266M-02B Bipolar (Series)

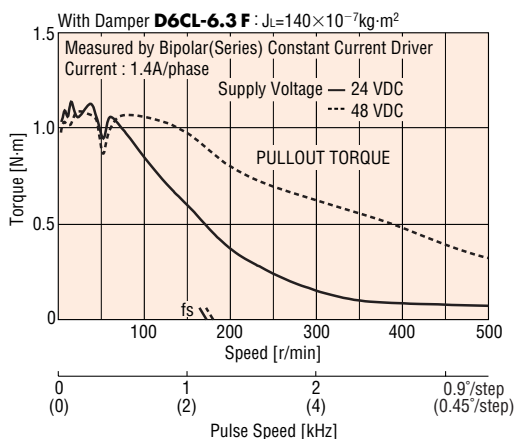

PK266M-02B Unipolar

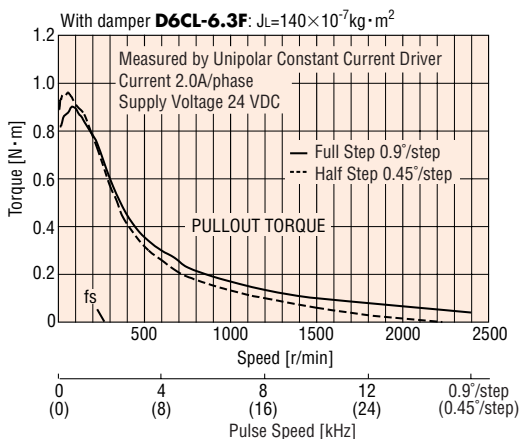

PK266M-03B Bipolar (Series)

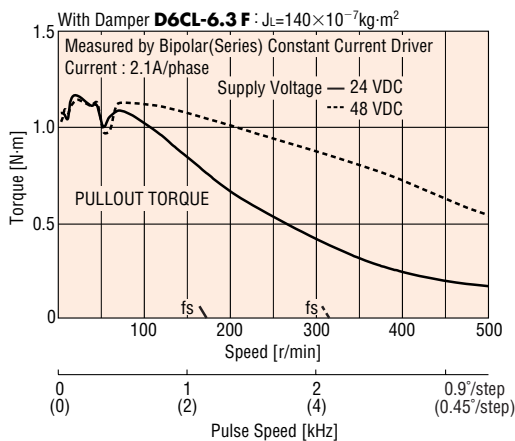

PK266M-03B Unipolar

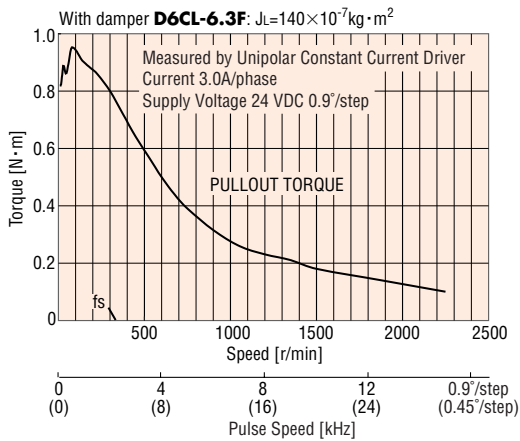

PK266M-E2.0B Bipolar (Parallel)

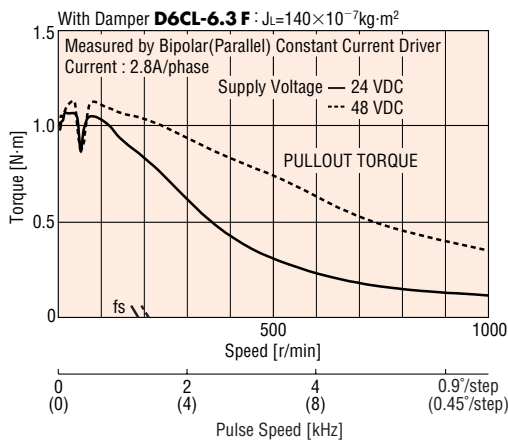

PK266M-E2.0B Bipolar (Series)

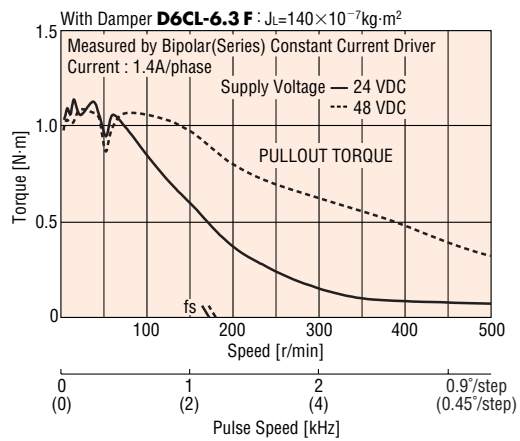

● **PK268M-01B** Bipolar (Series)

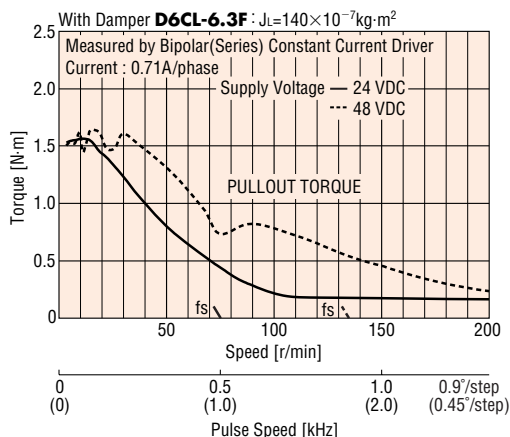

● **PK268M-01B** Unipolar

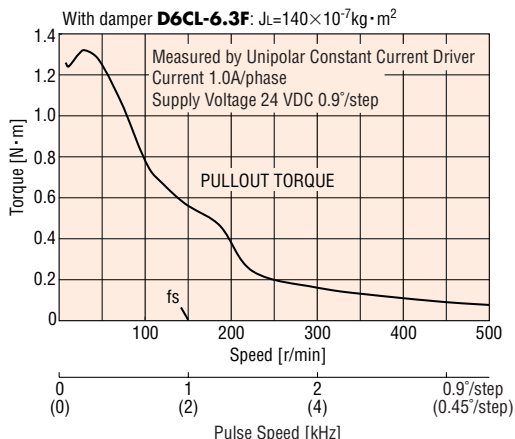

● **PK268M-02B** Bipolar (Series)

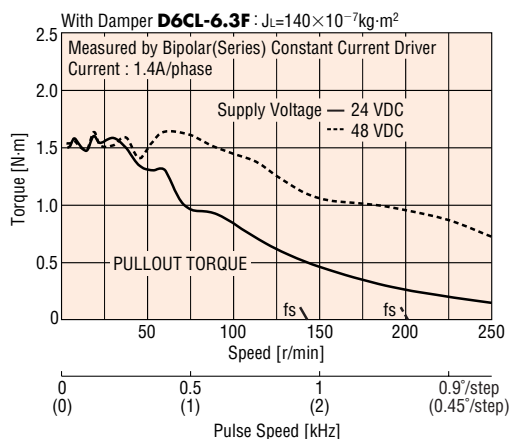

● **PK268M-02B** Unipolar

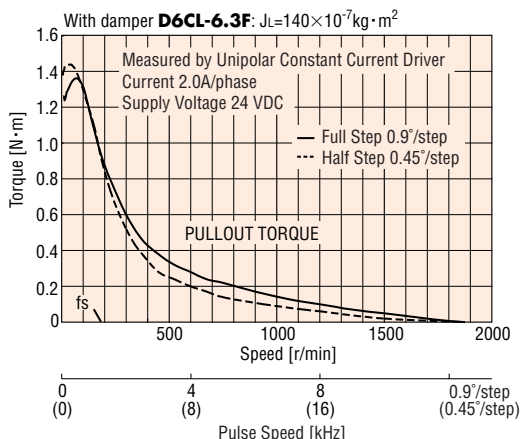

● **PK268M-03B** Bipolar (Series)

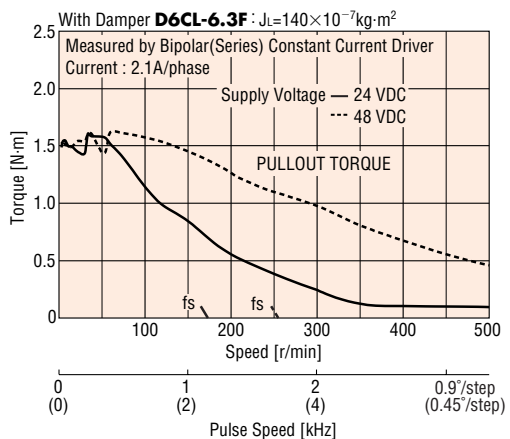

● **PK268M-03B** Unipolar

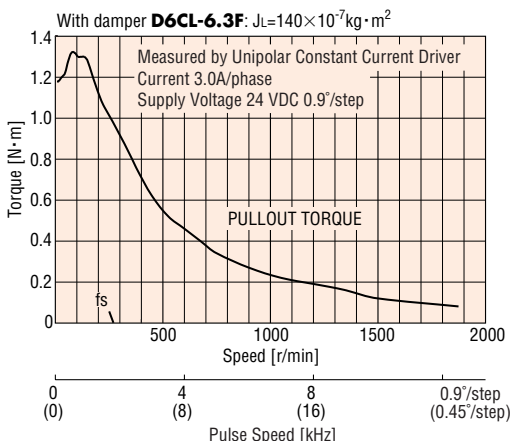

● **PK268M-E2.0B** Bipolar (Parallel)

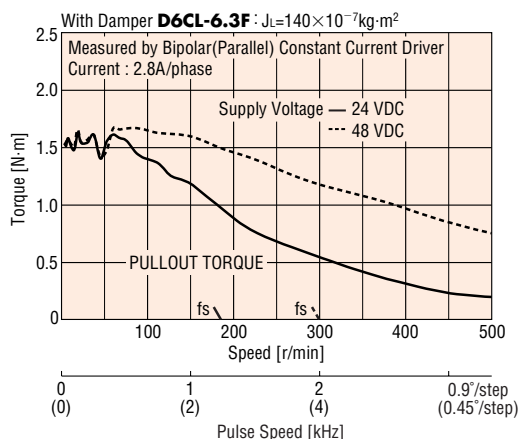

● **PK268M-E2.0B** Bipolar (Series)

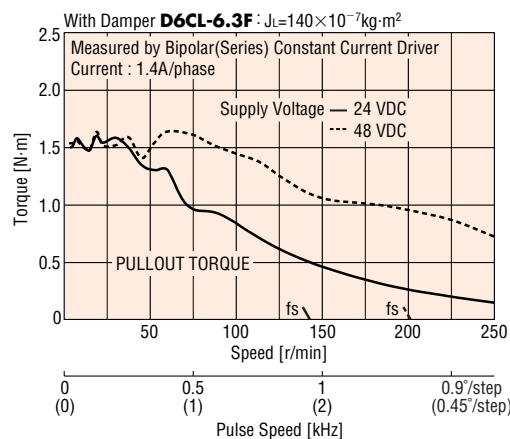

SH Geared Type

 60mm



Specifications

● Motor Specifications

Model	Connection Type	Current per Phase	Voltage	Resistance per Phase	Inductance	Rotor Inertia J	Lead Wires (Pin)	Connection Diagram
Single Shaft Double Shaft		A/phase	V DC	Ω/phase	mH/phase	kg·m ²		(see page B-197)
PK264AE-SG PK264BE-SG 	Bipolar (Parallel)	2.8	1.96	0.7	1.4	120×10 ⁻⁷	8	6
	Bipolar (Series)	1.4	3.9	2.8	5.6			5
	Unipolar	2	2.8	1.4	1.4			4

*Enter the gear ratio in the box (□) within the model name.

●Degree of Protection: IP30

● Gearmotor Specifications

Model	Gear Ratio	Holding Torque	Step Angle	Permissible Speed	Permissible Thrust Load	Permissible Overhung Load
Single Shaft Double Shaft		N·m		r/min	N	(at 10mm from shaft end) N
PK264AE-SG3.6 PK264BE-SG3.6	1:3.6	1	0.5°	500	30	50
PK264AE-SG7.2 PK264BE-SG7.2	1:7.2	2	0.25°	250	30	50
PK264AE-SG9 PK264BE-SG9	1:9	2.5	0.2°	200	30	50
PK264AE-SG10 PK264BE-SG10	1:10	2.7	0.18°	180	30	50
PK264AE-SG18 PK264BE-SG18	1:18	3	0.1°	100	30	120
PK264AE-SG36 PK264BE-SG36	1:36	4	0.05°	50	30	120

■ Dimensions unit: mm

- **PK264AE-SG** (Single Shaft) Mass 0.75 kg
- **PK264BE-SG** (Double Shaft) Mass 0.75 kg

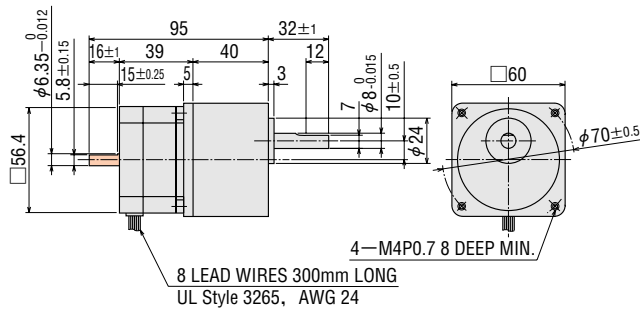

Mounting Screws (included)
M4 P0.7 15mm long: 4 pieces

● This dimension is for double shaft models. For single shaft, ignore the colored area.

Speed-Torque Characteristics

fs: Maximum Starting Pulse Rate

● PK264BE-SG Bipolar (Series) 24 VDC

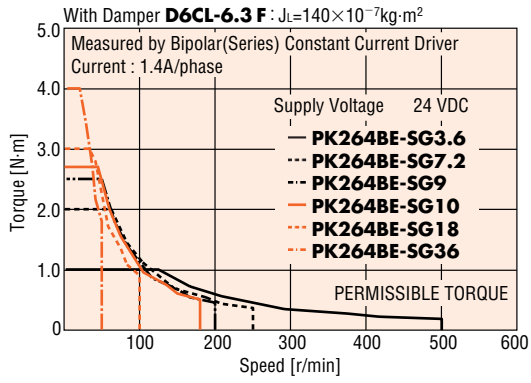

● PK264BE-SG Unipolar

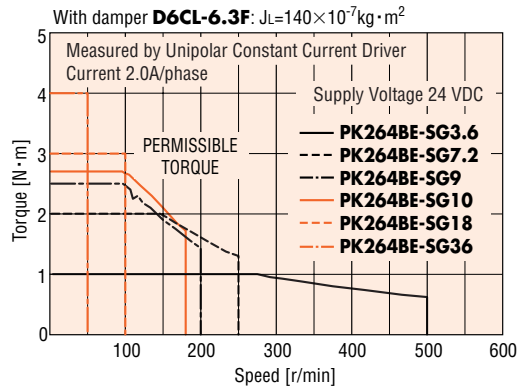

● PK264BE-SG Bipolar (Series) 48 VDC

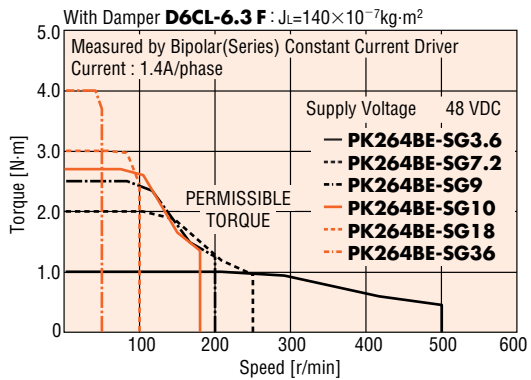













J Type (High Inertia Capability)

60mm

Step Angle 1.8°



Specifications

Model	Connection Type	Holding Torque	Current per Phase	Voltage	Resistance per Phase	Inductance	Rotor Inertia J	Lead Wires (Pin)	Connection Diagram (see page B-197)
Single Shaft Double Shaft		N·m	A/phase	V DC	Ω/phase	mH/phase	kg·m ²		
PK264JDA PK264JDB	Bipolar	1.06	2.8	2.1	0.73	1.8	280×10 ⁻⁷	4	
PK264JA PK264JB	Bipolar (Series)	1.06	1.4	4.1	2.92	7.2	280×10 ⁻⁷	6	
	Unipolar	0.75	2	2.9	1.46	1.8			
PK266JDA PK266JDB	Bipolar	1.75	2.8	2.8	1	3.05	450×10 ⁻⁷	4	
PK266JA PK266JB	Bipolar (Series)	1.75	1.4	5.6	4	12.2	450×10 ⁻⁷	6	
	Unipolar	1.35	2	4	2	3.05			
PK267JDA PK267JDB	Bipolar	2.2	2.8	3.4	1.2	3.54	570×10 ⁻⁷	4	
PK267JA PK267JB	Bipolar (Series)	2.2	1.4	6.7	4.8	14.2	570×10 ⁻⁷	6	
	Unipolar	1.7	2	4.8	2.4	3.54			
PK269JDA PK269JDB	Bipolar	3.1	2.8	4.2	1.49	5.7	900×10 ⁻⁷	4	
PK269JA PK269JB	Bipolar (Series)	3.1	1.4	8.3	5.96	22.8	900×10 ⁻⁷	6	
	Unipolar	2.2	2	6	2.98	5.7			

●Degree of Protection: IP30

QSTEP

RK

CSK

PMC

NanoStep
RFK5-Phase
Stepping
Motors

CSK

2-Phase
Stepping
Motors

Controller

Accessories

Speed-Torque Characteristics

fs: Maximum Starting Pulse Rate

PK264JDB Bipolar

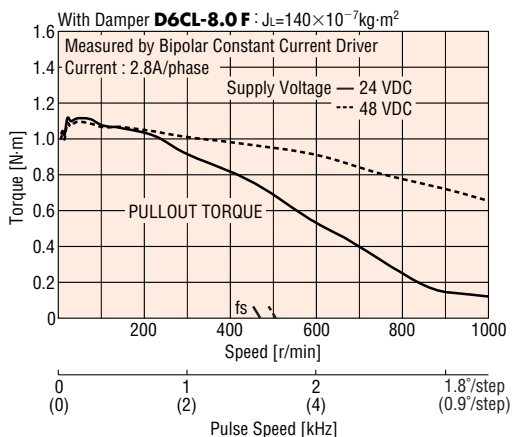

PK264JB Bipolar (Series)

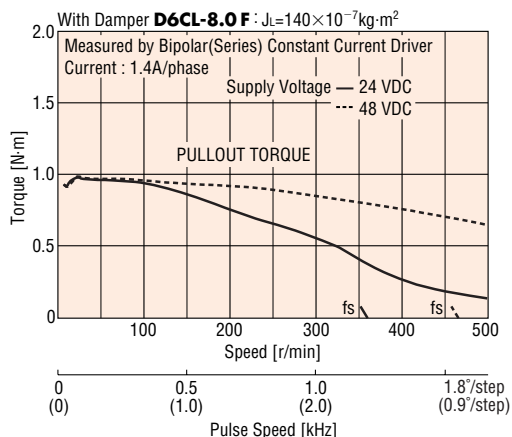

PK266JDB Bipolar

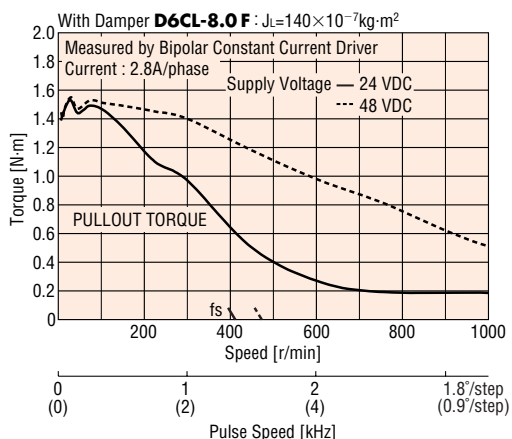

PK266JB Bipolar (Series)

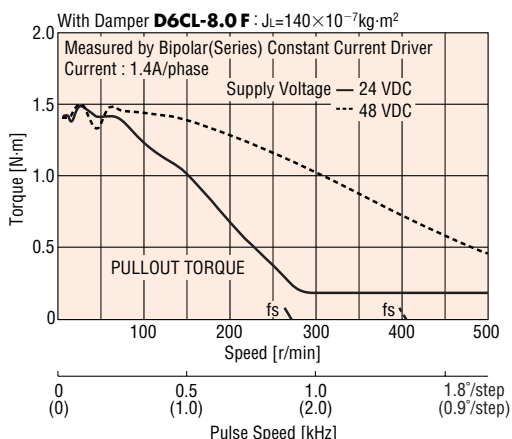

PK267JDB Bipolar

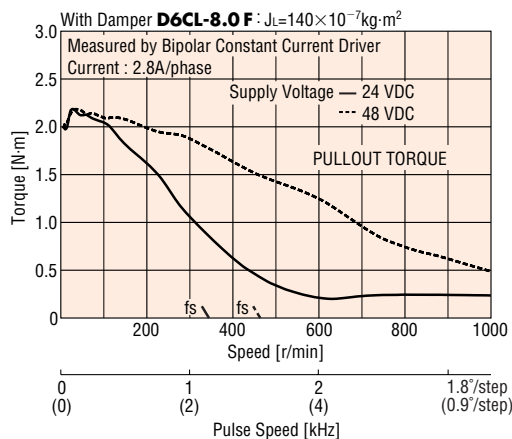

PK267JB Bipolar (Series)

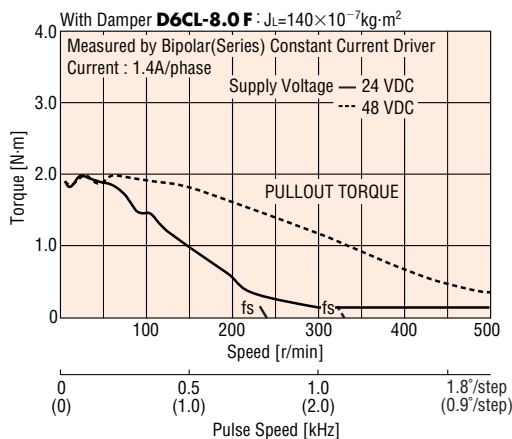

PK269JDB Bipolar

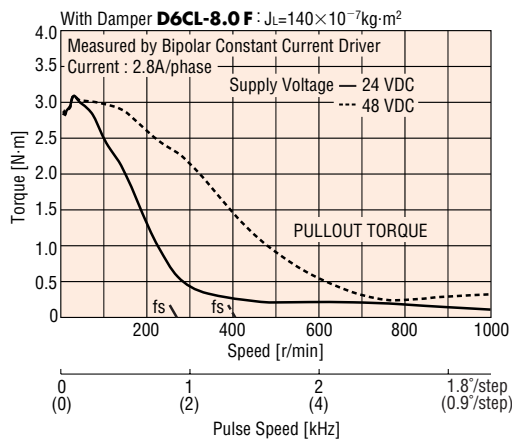

PK269JB Bipolar (Series)

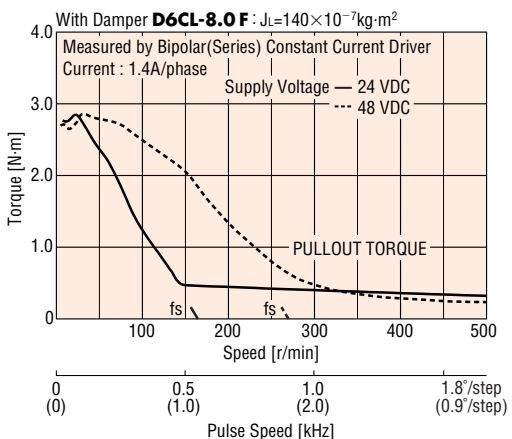

● **PK264JB** Unipolar

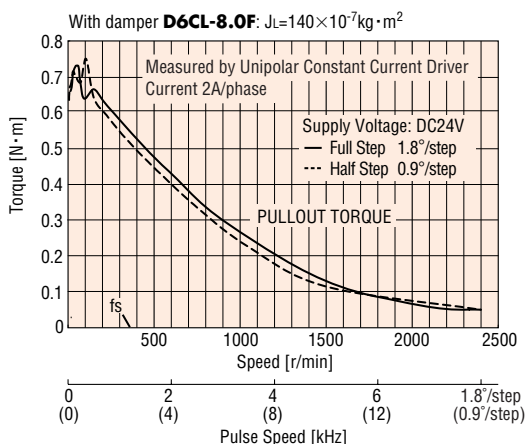

● **PK266JB** Unipolar

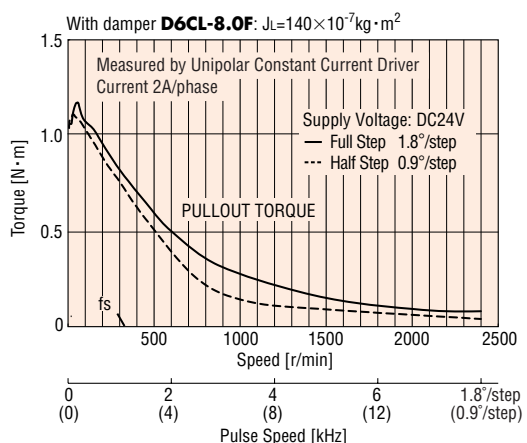

● **PK267JB** Unipolar

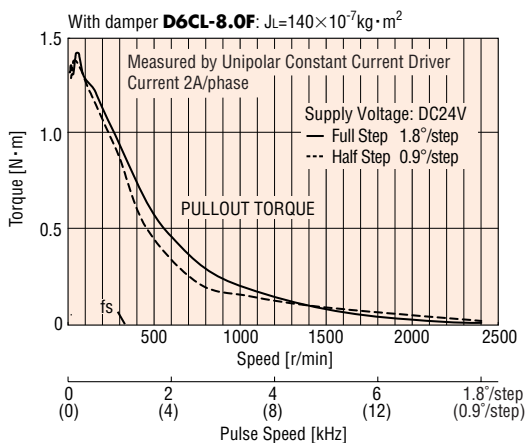

● **PK269JB** Unipolar

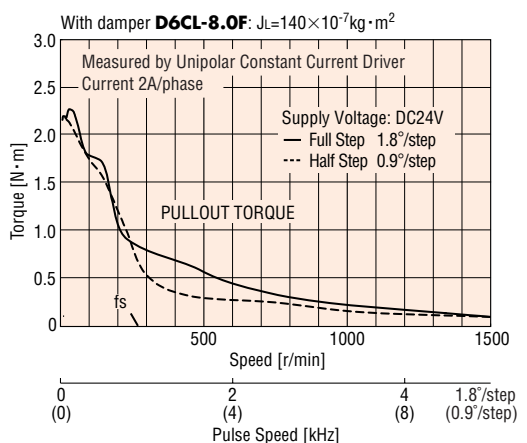

Product Number Code

PK 2 9 6 E A T

① ② ③ ④ ⑤ ⑥ ⑦

①	PK Series
②	2-Phase
③	Motor Frame Size 6 : 56.4 mm 9 : 85 mm
④	Motor Case Length
⑤	D : 4 terminals (Bipolar) E : 8 terminals
⑥	Motor Shaft Type A : Single Shaft
⑦	IP65 Rated Motor

Specifications

Model	Connection Type	Holding Torque N·m	Current per Phase A/phase	Voltage VDC	Resistance per Phase Ω/phase	Inductance mH/phase	Rotor Inertia J kg·m ²	Basic Step Angle	Number of Terminals	Mass kg
PK264DAT	Bipolar	0.48	2.8	1.96	0.7	1.4	120 × 10 ⁻⁷	1.8°	4	0.6
PK266DAT	Bipolar	1.17	2.8	2.52	0.9	2.5	300 × 10 ⁻⁷		4	0.9
PK268DAT	Bipolar	1.75	2.8	3.16	1.13	3.6	480 × 10 ⁻⁷		4	1.2
PK296EAT	Bipolar (Parallel)	3.1	6.3	1.4	0.24	1.5	1400 × 10 ⁻⁷		8	2.1
	Bipolar (Series)	3.1	3.18	2.8	0.96	6.0				
	Unipolar	2.2	4.5	2	0.48	1.5				
PK299EAT	Bipolar (Parallel)	6.2	6.3	1.9	0.33	2.5	2700 × 10 ⁻⁷		8	3.2
	Bipolar (Series)	6.2	3.18	3.9	1.32	10.0				
	Unipolar	4.4	4.5	2.8	0.66	2.5				
PK2913EAT	Bipolar (Parallel)	9.3	5.6	2.6	0.49	4.2	1400 × 10 ⁻⁷		8	4.3
	Bipolar (Series)	9.3	2.8	5.3	1.94	16.8				
	Unipolar	6.6	4	3.8	0.97	4.2				

General Specifications

Specifications		Motor
Degree of Protection		IP65 (except for mounting surface)
Insulation Class		Class B (130°C) [Recognized as class A (105°C) by UL/CSA standards]
Insulation Resistance		100 MΩ minimum under normal temperature and humidity, when measured by a 500 VDC megger between the windings and motor casing.
Dielectric Strength		Sufficient to withstand 1.5 kV, 50 Hz or 60 Hz applied between the windings and casing for one minute, under normal temperature and humidity.
Operating Environment (In Operation)	Ambient Temperature	-10°C ~ +50°C (nonfreezing)
	Ambient Humidity	85% or less (noncondensing)
	Atmosphere	No corrosive gases
Temperature Rise		Temperature rise of the coil measured by the change resistance method is 80°C or less. (at rated current, at standstill, two phases energized)
Static Angle Error*1		±3 arc minutes (±0.05°)
Shaft Runout		0.05 T.I.R. (mm)*4
Radial Play*2		0.025 mm Max. of 5 N
Axial Play*3		0.075 mm Max. of 10 N
Concentricity		0.075 T.I.R. (mm)*4
Perpendicularity		0.075 T.I.R. (mm)*4

- *1 This value is for full step under no load. (The value changes with the size of the load.)
- *2 Radial Play: Displacement in shaft position in the radial direction, when a 5 N load is applied in the vertical direction to the tip of the motor's shaft.
- *3 Axial Play: Displacement in shaft position in the axial direction, when a 10 N load is applied to the motor's shaft in the axial direction.
- *4 T.I.R. (Total Indicator Reading): The total dial gauge reading when the measurement section is rotated one revolution centered on the reference axis center.

Note:

- Do not measure insulation resistance or perform the dielectric strength test while the motor and driver are connected.

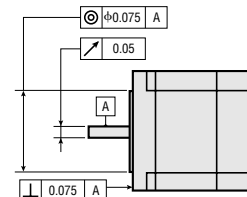

Permissible Overhung Load and Permissible Thrust Load

Unit=N

Model	Overhung Load Distance from Shaft End (mm)					Thrust Load
	0	5	10	15	20	
PK264DAT	54	67	89	130	-	The permissible thrust load shall be no greater than the motor mass.
PK266DAT						
PK268DAT						
PK296EAT	260	290	340	390	480	
PK299EAT						
PK2913EAT						

2-Phase Stepping Motor PK Series

Speed-Torque Characteristics fs: Maximum Starting Pulse Rate

● **PK264DAT** Bipolar

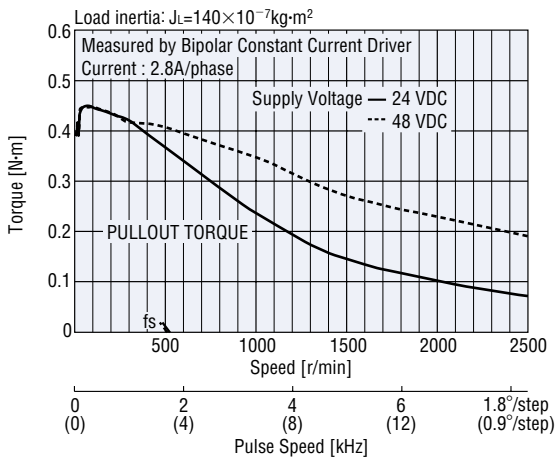

● **PK296EAT** Bipolar (Parallel)

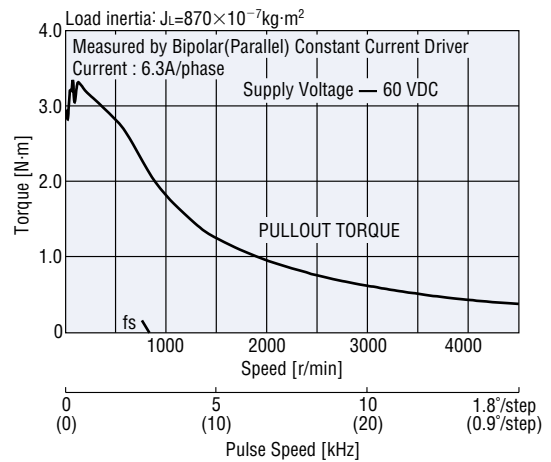

● **PK266DAT** Bipolar

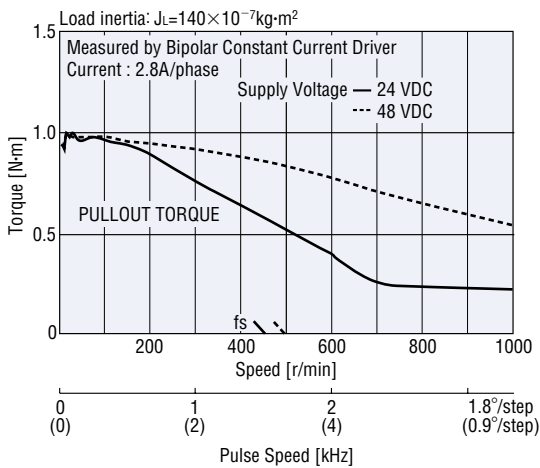

● **PK299EAT** Bipolar (Parallel)

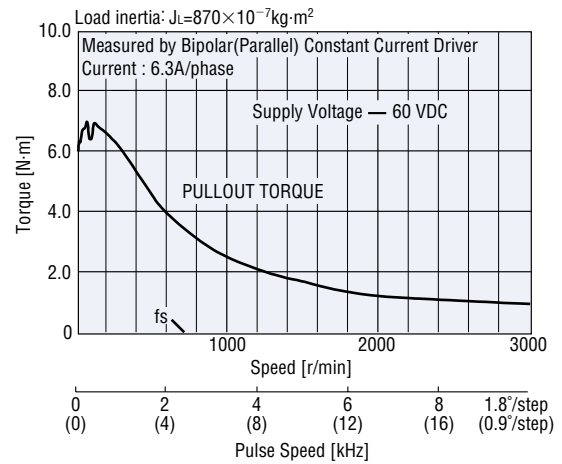

● **PK268DAT** Bipolar

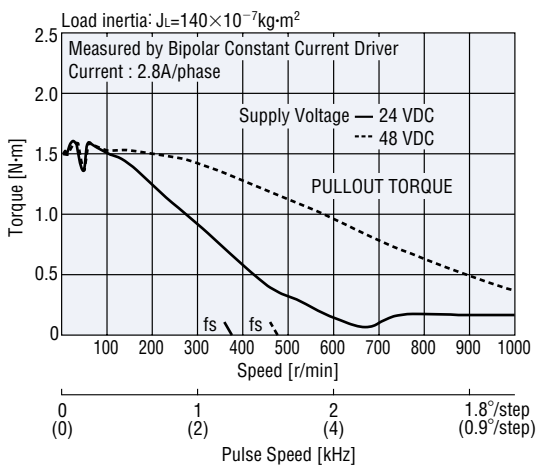

● **PK2913EAT** Bipolar (Parallel)

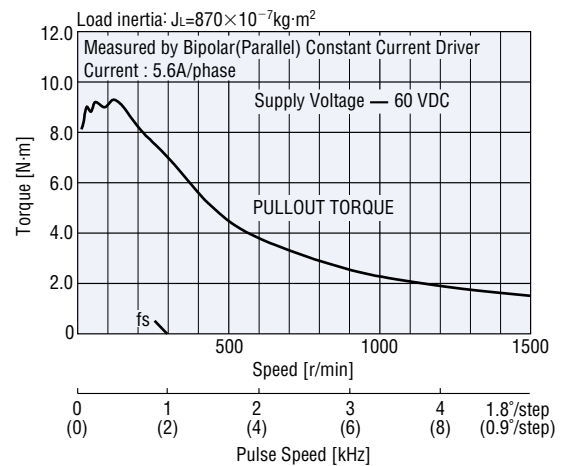

Standard Type IP65 Rated Motors

●PK296EAT Bipolar (Series)

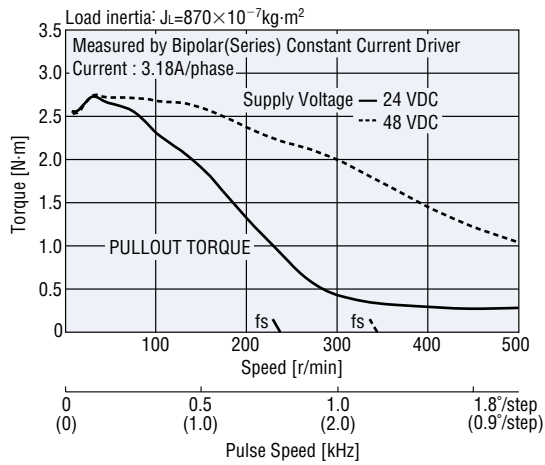

●PK299EAT Bipolar (Series)

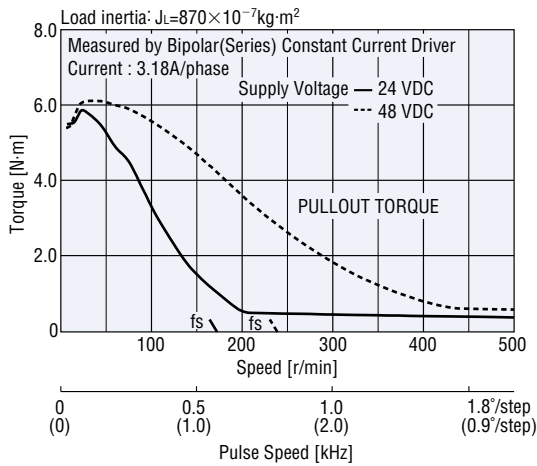

●PK2913EAT Bipolar (Series)

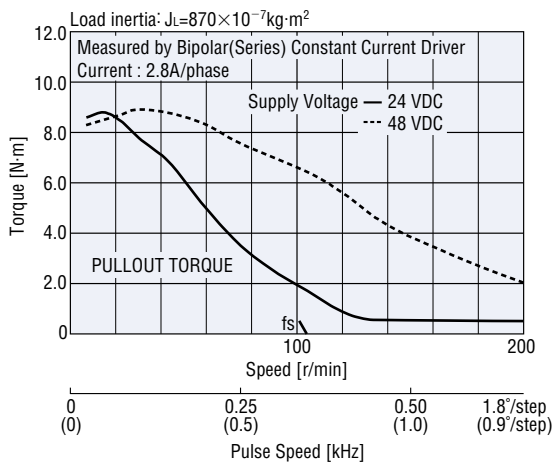

2-Phase Stepping Motor PK Series

■ Dimensions (Unit=mm)

□ 56.4 mm

Model	L	Mass (kg)
PK264DAT	83	0.6
PK266DAT	98	0.9
PK268DAT	120	1.2

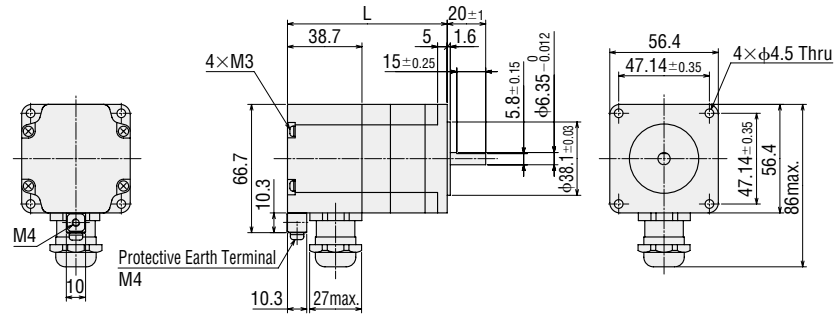

□ 85 mm

Model	L	Mass (kg)
PK296EAT	110	2.1
PK299EAT	140	3.2
PK2913EAT	170	4.3

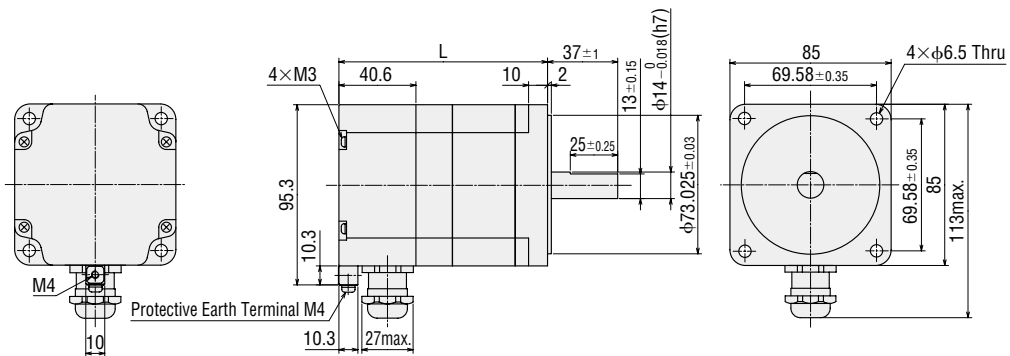

Standard Type IP65 Rated Motors

Connection Diagrams

56.4 mm

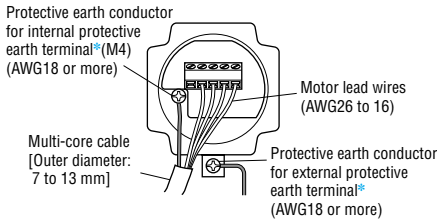

Connect motor lead wires to the terminals 2 to 5.

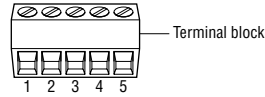

*Connect either the internal protective earth terminal or external protective earth terminal to the ground.

PK26 DAT (Bipolar Connection)

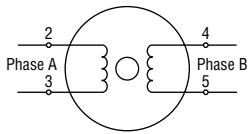

85 mm

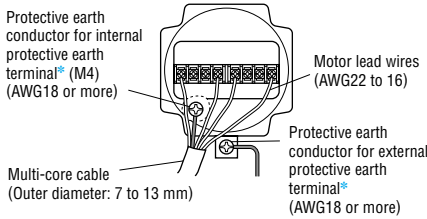

*Connect either the internal protective earth terminal or external protective earth terminal to the ground.

Series Bipolar Connection

Connect the supplied shorting bars (two pieces) as shown in the figure below.

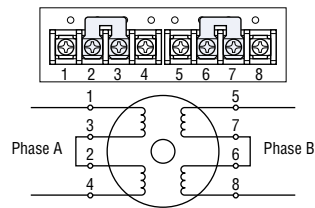

Parallel Bipolar Connection

Connect the supplied shorting bars (four pieces) as shown in the figure below.

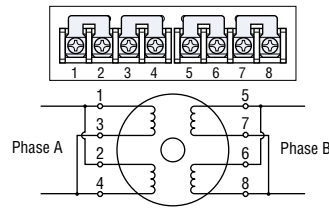

Unipolar Connection

Connect the supplied shorting bars (two pieces) as shown in the figure below.

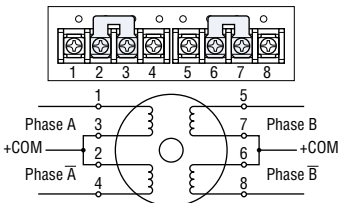

SH Geared Type

90mm



Specifications

● Motor Specifications

Model	Connection Type	Current per Phase A/phase	Voltage V DC	Resistance per Phase Ω/phase	Inductance mH/phase	Rotor Inertia J kg·m ²	Lead Wires (Pin)	Connection Diagram (see page B-197)
PK296AE-SG□ PK296BE-SG□	Bipolar (Parallel)	4.2	1	0.24	1.5	1400×10 ⁻⁷	8	6
	Bipolar (Series)	2.1	2	0.96	6.0			5
	Unipolar	3	1.4	0.48	1.5			4

*Enter the gear ratio in the box (□) within the model name.

●Degree of Protection: IP30

● Gearmotor Specifications

Model	Gear Ratio	Holding Torque N·m	Step Angle	Permissible Speed r/min	Permissible Thrust Load N	Permissible Overhung Load (at 10mm from shaft end) N
PK296AE-SG3.6 PK296BE-SG3.6	1:3.6	2.5	0.5°	500	100	300
PK296AE-SG7.2 PK296BE-SG7.2	1:7.2	5	0.25°	250	100	300
PK296AE-SG9 PK296BE-SG9	1:9	6.3	0.2°	200	100	300
PK296AE-SG10 PK296BE-SG10	1:10	7	0.18°	180	100	300
PK296AE-SG18 PK296BE-SG18	1:18	9	0.1°	100	100	300
PK296AE-SG36 PK296BE-SG36	1:36	12	0.05°	50	100	300

■ Dimensions unit: mm

- PK296AE-SG□ (Single Shaft) Mass 2.8 kg
- PK296BE-SG□ (Double Shaft) Mass 2.8 kg

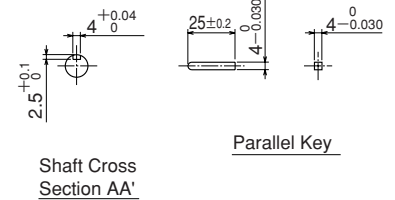
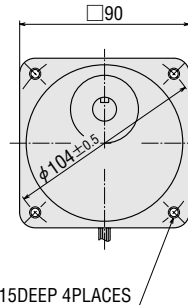
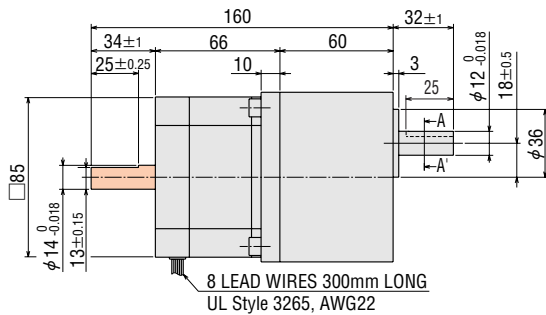

Mounting Screws (included)
M6 P1.0 18mm long: 4 pieces

●This dimension is for double shaft models. For single shaft, ignore the colored area.

Speed-Torque Characteristics

fs: Maximum Starting Pulse Rate

● PK296BE-SG □ Bipolar (Series) 24 VDC

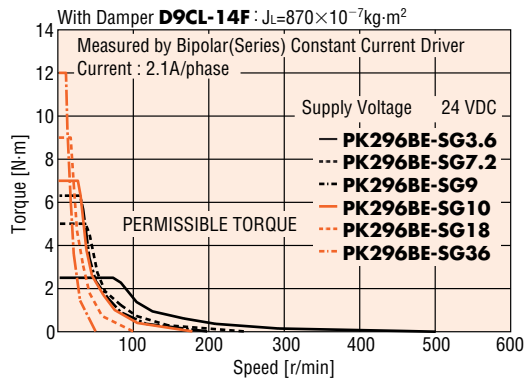

● PK296BE-SG □ Unipolar

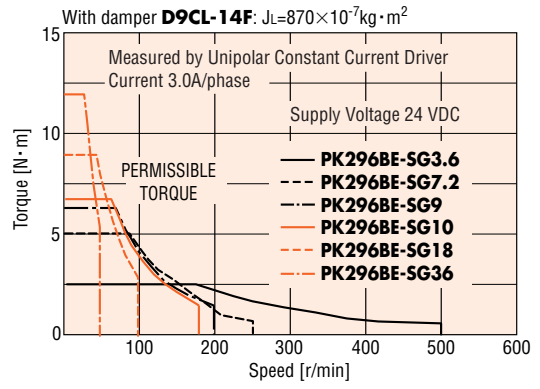

● PK296BE-SG □ Bipolar (Series) 48 VDC

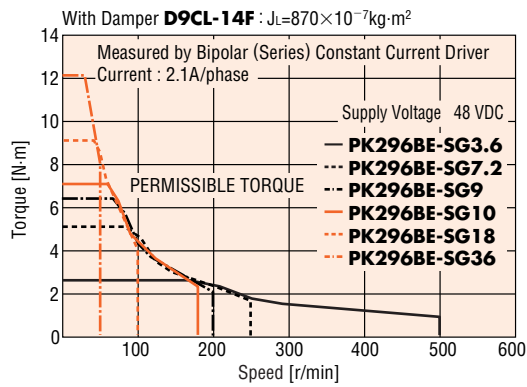

STEPPING MOTORS

QSTEP

RK

5-Phase with AC Driver

CSK

5-Phase with DC Driver

PMC

NanoStep RK

5-Phase Stepping Motors

CSK

2-Phase with DC Driver

2-Phase Stepping Motors

Controller

Accessories